

CHAPTER 10
GRADE SEPARATIONS AND INTERCHANGES

10.0	INTRODUCTION AND GENERAL TYPES OF INTERCHANGES	10-1
10.1	WARRANTS FOR INTERCHANGES AND GRADE SEPARATIONS	10-6
	10.1.1 Interchange and Grade Separation Warrants	10-6
10.2	ADAPTABILITY OF HIGHWAY GRADE SEPARATIONS AND INTER-CHANGES.....	10-7
10.3	GRADE SEPARATION STRUCTURES	10-8
10.4	INTERCHANGES.....	10-8
	10.4.1 General.....	10-8
10.5	GENERAL DESIGN CONSIDERATIONS.....	10-9
	10.5.1 Determination of Interchange Configuration.....	10-10
	10.5.2 Approaches to the Structure.....	10-11
	10.5.2.1 Alignment, Profile, and Cross Section	10-11
	10.5.2.2 Sight Distance	10-12
	10.5.3 Interchange Spacing.....	10-12
	10.5.4 Uniformity of Interchange Patterns	10-12
	10.5.5 Route Continuity.....	10-12
	10.5.6 Coordination of Lane Balance and Basic Number of Lanes.....	10-12
	10.5.7 Auxiliary Lanes.....	10-15
	10.5.8 Lane Reduction	10-15
	10.5.9 Weaving Sections.....	10-15
	10.5.10 Collector-Distributor Roads.....	10-21
	10.5.11 Two-Exit Versus Single-Exit Interchange Design.....	10-21
	10.5.12 Wrong-Way Entrances.....	10-21
10.6	RAMPS.....	10-21
	10.6.1 Types and Examples	10-21
	10.6.2 General Ramp Design Considerations	10-22
	10.6.2.1 Design Speed	10-22
	10.6.2.2 Curvature	10-23
	10.6.3 Stopping Sight Distance.....	10-23
	10.6.4 Ramp Profiles.....	10-23
	10.6.5 Superelevation and Cross Slope.....	10-25
10.7	INTERCHANGE DESIGN CRITERIA	10-26
	10.7.1 General.....	10-26
	10.7.2 Sight Distance	10-26
	10.7.3 Sight Distance to Exit Nose	10-26
	10.7.4 Gores.....	10-29
	10.7.5 Ramp Pavement Widths.....	10-32
	10.7.5.1 Width and Cross Section.....	10-32
	10.7.5.2 Shoulders and Lateral Clearances.....	10-32
	10.7.6 Ramp Terminals.....	10-32
	10.7.6.1 Right-Hand Entrances and Exits.....	10-33
	10.7.6.2 Left-Hand Entrances and Exits	10-33
	10.7.6.3 Terminal Location and Sight Distance	10-33
	10.7.6.4 Speed-Change Lanes.....	10-35
	10.7.7 Single Lane Free-Flow Terminals, Entrances.....	10-43

10.7.7.1 Taper Type Entrance.....	10-43
10.7.7.2 Parallel-Type Entrance	10-43
10.7.8 Single-Lane Free-Flow Terminals, Exits.....	10-43
10.7.8.1 Taper Type Exits.....	10-46
10.7.8.2 Parallel Type Exits.....	10-46
10.7.8.3 Free-Flow Terminals on Curves	10-47
10.7.8.4 At-Grade Terminals	10-47
10.7.9 Multilane Free-Flow Terminals	10-50
10.7.9.1 Two-Lane Entrances	10-50
10.7.9.2 Two-Lane Exits	10-50
10.7.9.3 Major Forks and Branch Connections and Freeway-to-Freeway Connections	10-53
10.8 PEDESTRIANS	10-53
10.9 RAMP METERING.....	10-54
REFERENCES	10-55

List of Tables

Table 10-1 Guide Values for Ramp Design Speed as Related to Highway Design Speed.....	10-23
Table 10-2 Maximum Algebraic Difference in Pavement Cross Slope at Turning Roadway Terminals	10-25
Table 10-3 Minimum Deceleration Lengths for Exit Terminals With Flat Grades of 2 Percent or Less.....	10-36
Table 10-4 Minimum Acceleration Lengths for Entrance Terminals With Flat Grades of 2 Percent or Less	10-37
Table 10-5 Speed-Change Lane Adjustment Factors as a Function of Grade.....	10-38
Table 10-6 Minimum Length of Taper Beyond an Offset Nose.....	10-46

List of Figures

Figure 10-1A Interchange Types	10-2
Figure 10-1B Interchange Types	10-3
Figure 10-1C Interchange Types	10-4
Figure 10-1D Interchange Types	10-5
Figure 10-1E Interchange Types.....	10-6
Figure 10-2 Typical Examples of Lane Balance.....	10-13
Figure 10-3 Coordination of Lane Balance and Basic Number of Lanes	10-14
Figure 10-4A Types of Weaving Sections.....	10-16
Figure 10-4B Types of Weaving Sections	10-17
Figure 10-5A Lane Configuration of Weaving Sections	10-19
Figure 10-5B Lane Configuration of Weaving Sections.....	10-20
Figure 10-6 Location of Ramp Intersections on the Cross Road	10-27
Figure 10-7 Measurement of Sight Distance at Ramp Terminals with Stop Controls	10-28
Figure 10-8 Typical Gore Area Characteristic.....	10-29
Figure 10-9 Traveled Way Narrowing on Entrance Ramps.....	10-31
Figure 10-10 Recommended Minimum Ramp Terminal Spacing	10-34
Figure 10-11A Typical Single-Lane Entrance Ramps (Tapered)	10-39
Figure 10-11B Typical Single-Lane Entrance Ramps (Parallel) (Preferred).....	10-40

Figure 10-12 Freeway Entrance Terminal – Taper Type.....	10-41
Figure 10-13 Freeway Entrance Terminal – Parallel Type (Preferred)	10-42
Figure 10-14 Freeway Exit Terminal – Taper Type	10-44
Figure 10-15 Freeway Exit Terminal – Parallel Type	10-45
Figure 10-16A Single-Lane Ramp Exit Transition to Two Lanes (Alternate A).....	10-48
Figure 10-16B Single-Lane Ramp Exit Transition to Two Lanes (Alternate B)	10-49
Figure 10-17 Two-Lane Entrance or Branch Connection.....	10-51
Figure 10-18 Two Lane Exit or Major Fork	10-52

CHAPTER 10

GRADE SEPARATIONS AND INTERCHANGES

10.0 INTRODUCTION AND GENERAL TYPES OF INTERCHANGES

The ability to accommodate high volumes of traffic safely and efficiently through intersections depends largely on the arrangement that is provided for handling intersecting traffic. The greatest efficiency, safety, and capacity, and least amount of air pollution are attained when the intersecting through traffic lanes are grade separated. An interchange is a system of interconnecting roadways in conjunction with one or more grade separations that provide for the movement of traffic between two or more roadways or highways on different levels.

Interchange design is the most specialized and highly developed form of intersection design. The designer should be thoroughly familiar with the material in Chapter 9 before starting the design of an interchange. Relevant portions of the following material covered in Chapter 9 also apply to interchange design:

- general factors affecting design
- basic data required
- principles of channelization
- design procedure
- design standards

Material previously covered is not repeated. The discussion which follows covers modifications in the above-mentioned material and additional material pertaining exclusively to interchanges.

The economic effect on abutting properties resulting from the design of an intersection at-grade is usually confined to the area in the immediate vicinity of the intersection. An interchange or series of interchanges on a freeway or expressway through a community may affect large contiguous areas or even the entire community. For this reason, consideration should be given to an active public process to encourage context sensitive solutions. Interchanges must be located and designed to provide the most desirable overall plan of access, traffic service, and community development.

The type of grade separation and interchange, along with its design, is influenced by many factors such as highway classification, character and composition of traffic, design speed, and degree of access control. These controls plus signing requirements, economics, terrain, environment, and right-of-way are of great importance in designing facilities with adequate capacity to safely accommodate the traffic demands. Interchange types are characterized by the basic shapes of ramps, namely, diamond, loop, directional, "urban" and cloverleaf interchanges. Figures 10-1A, B, C, D and E illustrate these basic interchange types. These examples can further be classified as either local street interchanges or freeway-to-freeway interchanges.

Although each interchange presents an individual challenge, it must also be considered in conjunction with adjacent interchanges, driver expectancy, and at-grade intersections in the corridor as a whole. For further information, see Chapter 10 of the *PGDHS (1)*. A more detailed description of all the basic types is found later in this chapter.

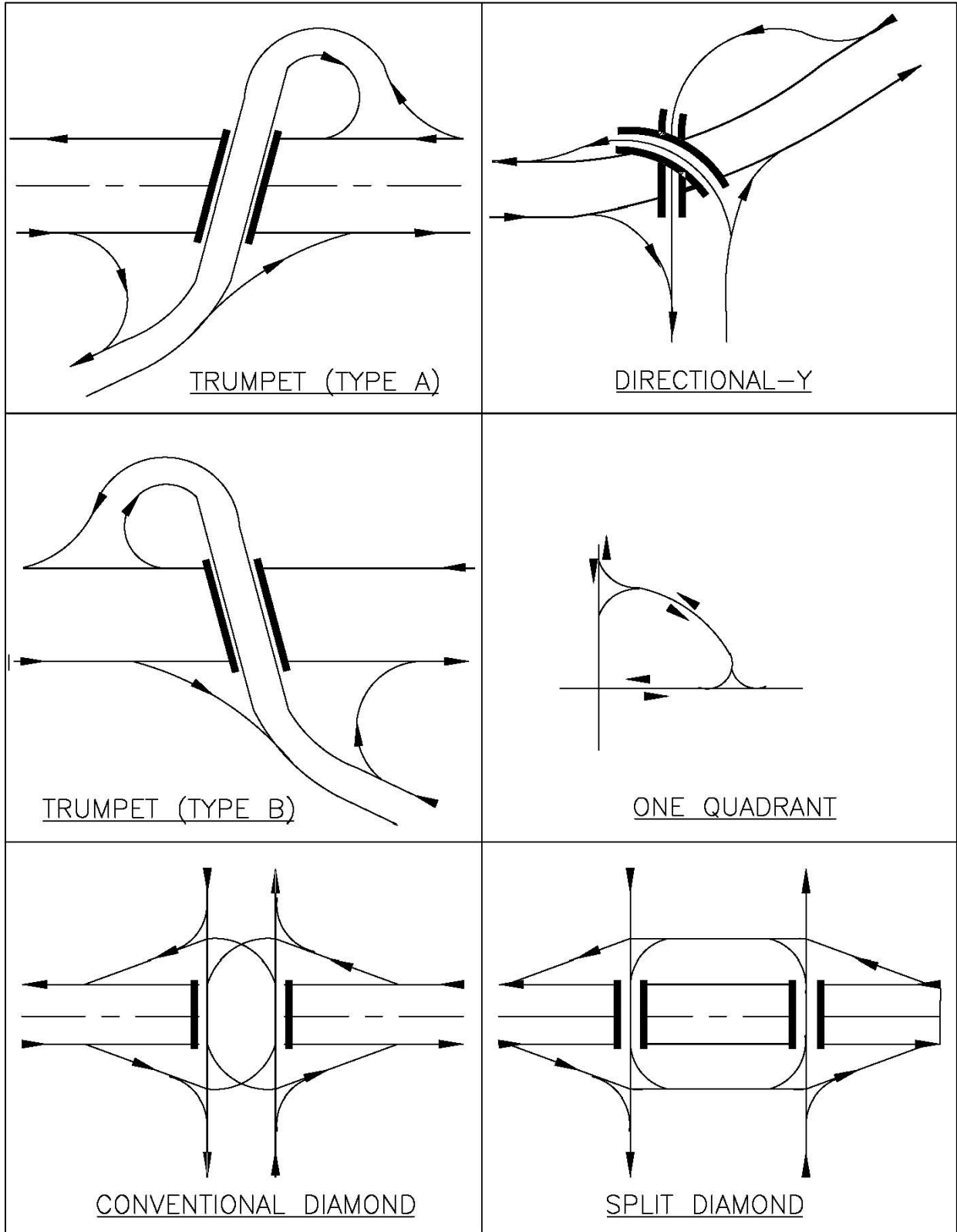

Figure 10-1A Interchange Types

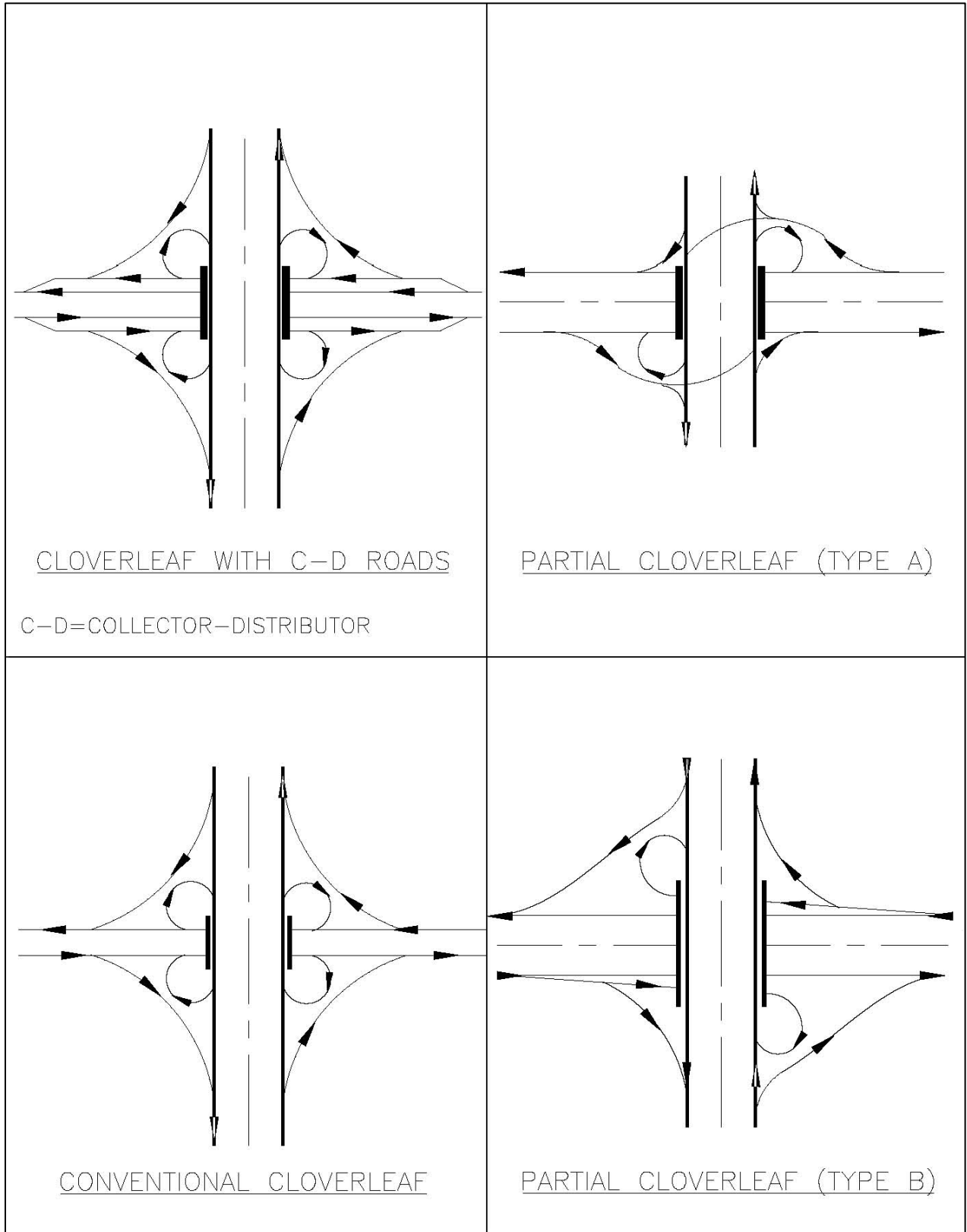

Figure 10-1B Interchange Types

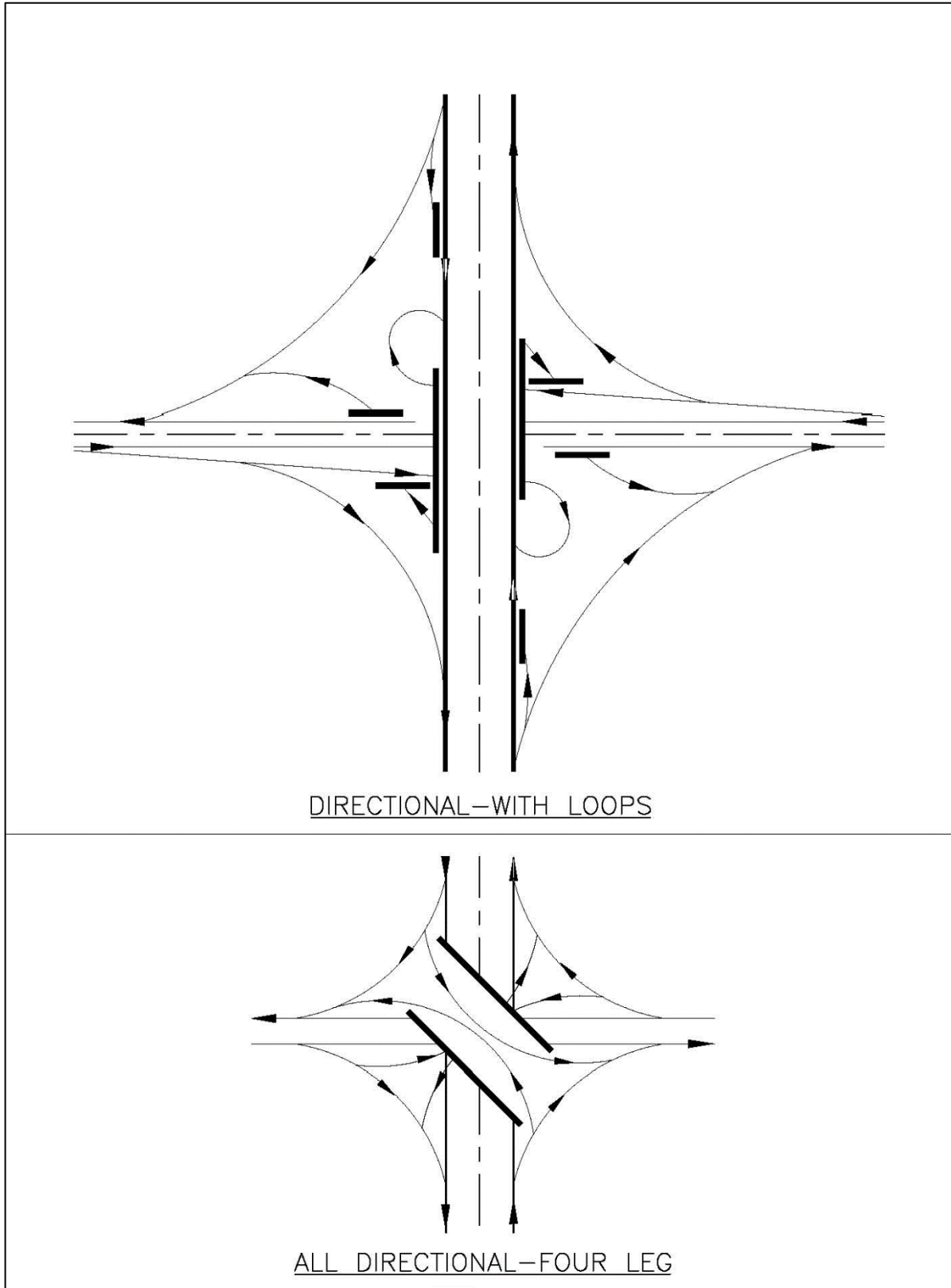

Figure 10-1C Interchange Types

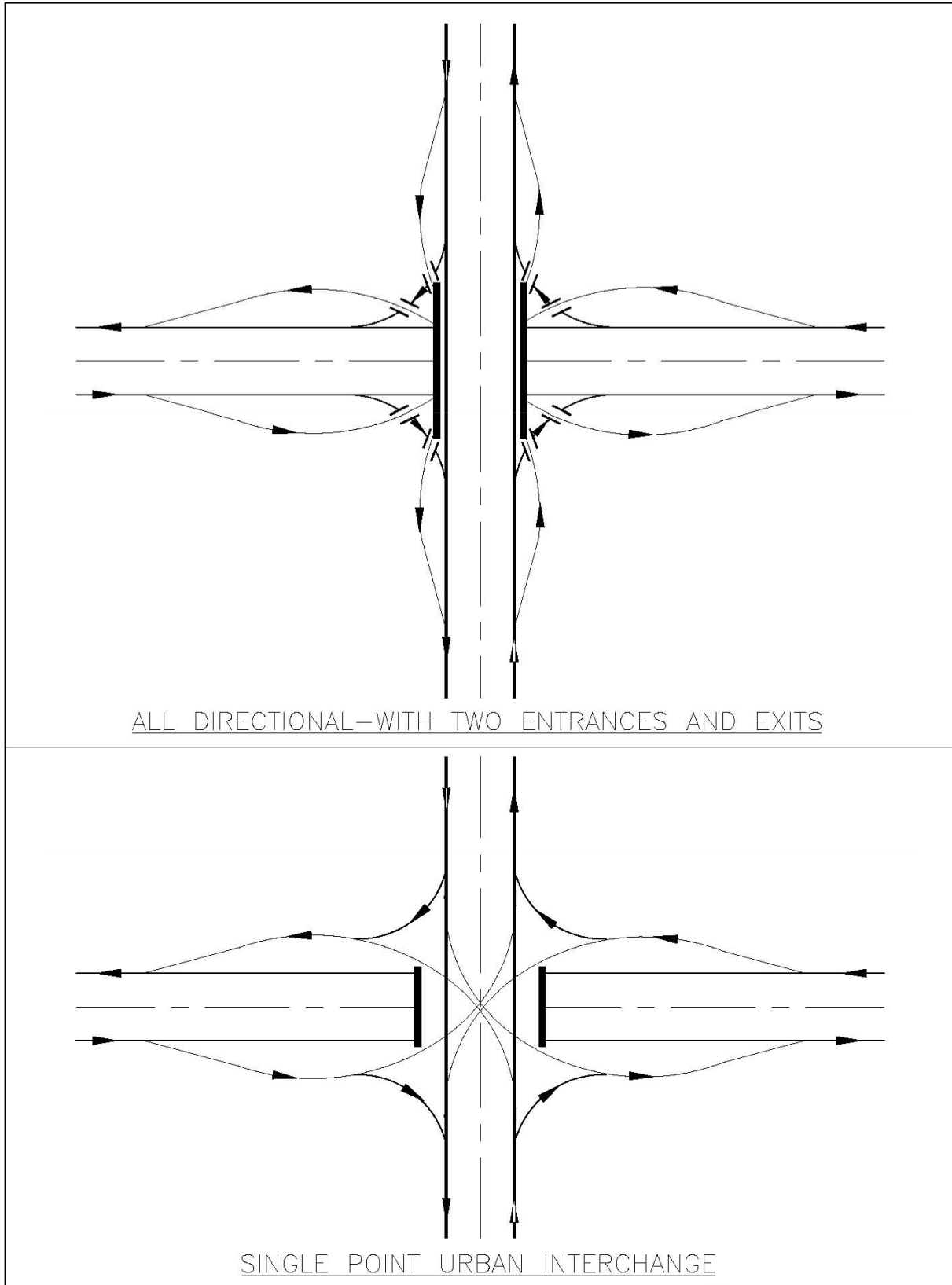

Figure 10-1D Interchange Types

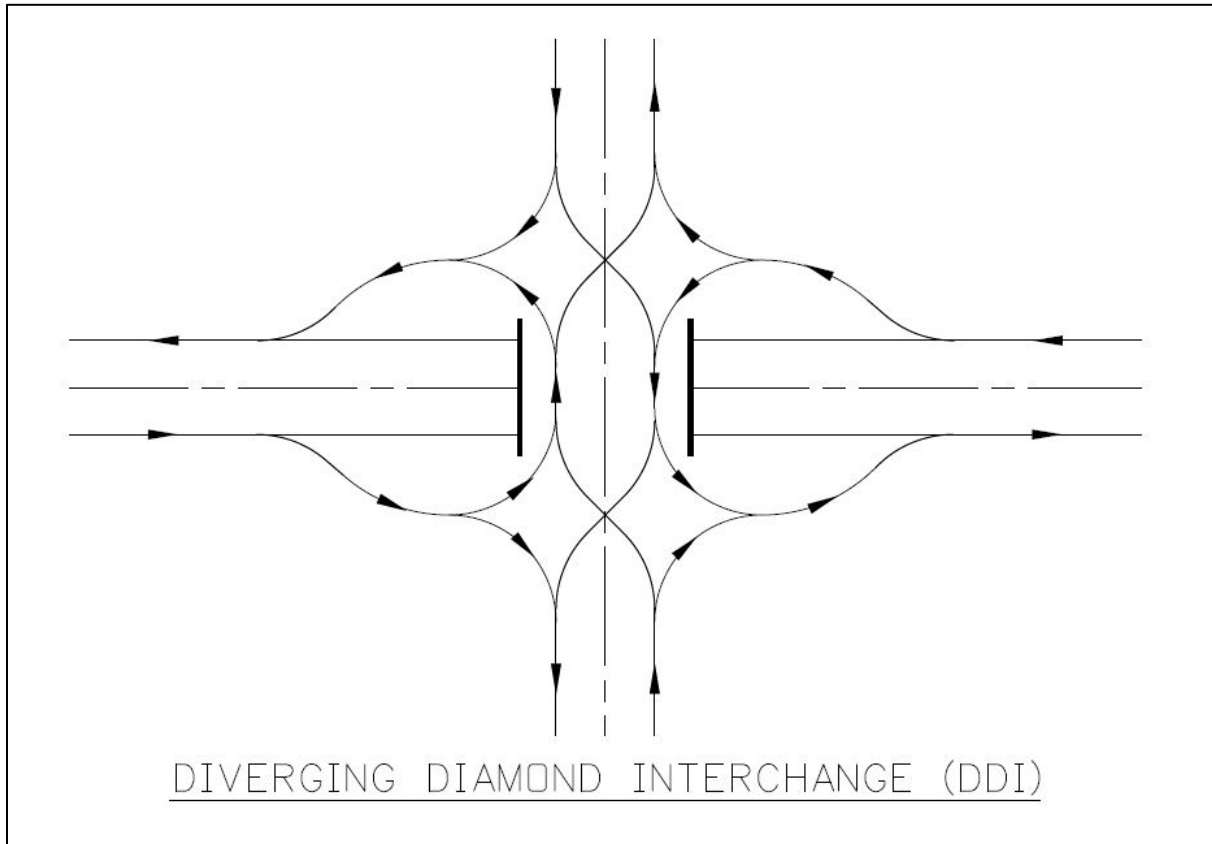

Figure 10-1E Interchange Types

10.1 WARRANTS FOR INTERCHANGES AND GRADE SEPARATIONS

10.1.1 Interchange and Grade Separation Warrants

All connections to freeways are by traffic interchanges. An interchange or separation may be warranted as part of an expressway (or in special cases at the junction of two non-access controlled highways). Because of the wide variety of site conditions, traffic volumes, highway types, and interchange layouts, the warrants that justify an interchange may differ at each location. Warrants, therefore, are necessarily general and must be based on engineering judgment. *CDOT Policy Directive 1601.0 (2)* must be followed. When determining conditions that may warrant an interchange, the following should be considered:

- Design designation
- Reduction of bottlenecks or spot congestion
- Reduction of crash frequency and severity – Some at-grade intersections have a disproportionate frequency of serious crashes. If inexpensive methods of reducing crashes are likely to be ineffective or impractical, a highway grade separation or interchange may be warranted. Higher crash frequencies are often found at intersections between comparatively lightly-traveled highways in sparsely settled rural areas where speeds are high. Serious crashes at heavily traveled intersections may also warrant interchange facilities. In addition to the

reduction in crash frequency and severity, the operational efficiency for all traffic movements is also improved with interchanges.

- Site topography - The site topography and the grades of the intersecting roadways are important to determine interchange type and location. The right-of-way required for an interchange is dependent largely on the type of highway, topography, and the overall type of interchange.
- Road-user benefits
- Traffic volume warrant - Except on freeways, interchanges usually are provided only where crossing and turning traffic cannot readily be accommodated on a less costly at-grade intersection.
- Transit
- Functional classification of the road

10.2 ADAPTABILITY OF HIGHWAY GRADE SEPARATIONS AND INTER-CHANGES

The three types of intersections are:

- at-grade intersections
- highway grade separations without ramps
- interchanges

Factors that would determine the need for an interchange and its type:

- Traffic and Operation
- Site Conditions
- Type of Highway - The hazard from stopping and direct turns at an intersection increases with the design speed so that high-design-speed highways warrant interchange treatment earlier than low-design-speed roads with similar traffic volumes.
- Intersecting Facility - The extent or degree to which local service must be maintained or provided also is of concern in the selection of the type of intersection. Local service can be provided readily on certain types of at-grade intersections, whereas considerable additional facilities may be necessary on some types of interchanges.
- Safety
- Stage Development - Where the ultimate development consists of a single grade-separation structure, stage construction may not be economical unless provisions are made in the original design for a future stage of construction. Ramps, however, are well adapted to stage development.
- Economics - Initial cost needs to be considered. The interchange is the costliest type of intersection because of the cost of the structure, ramps, through roadways, grading and landscaping of large areas.
- Maintenance costs may be a factor in the type of intersection. Interchanges have large pavement and variable slope areas, the maintenance of which, together with that of the structure, signs, and landscaping, exceeds that of an at-grade intersection.

In a complete analysis of the adaptability of interchanges, it is necessary to compare vehicular operating costs of all traffic with those for other intersections.

10.3 GRADE SEPARATION STRUCTURES

In any single separation structure, care should be exercised in maintaining a constant clear roadway width and a uniform protective railing or parapet.

The type of structure best suited to grade separations is one that gives drivers little sense of restriction. Where drivers take practically no notice of a structure over which they are crossing, sudden and erratic changes in speed and/or direction are unlikely. On the other hand, it is virtually impossible not to notice a structure overpassing the roadway being used. For this reason, every effort should be made to design the structure so that it fits the environment in a pleasing and functional manner without drawing unnecessary or distracting attention.

A detailed study should be made at each proposed highway grade separation to determine whether the main road should be carried over or under the structure. Often the choice is dictated by features such as cost, environmental impacts, topography, or highway classification. It may be necessary to make several nearly complete preliminary layout plans before a decision regarding the most desirable general layout plan can be reached.

As a rule, a design that best fits the existing topography is the most economical to construct and maintain, and this factor becomes the first consideration in design.

The clear width on bridges should be as wide as the approach pavement including shoulders, in order to give the driver a secure feeling. When the full approach roadway is continued across the structure, the parapet rail, both left and right, should align with the guardrail on the approach roadway.

Minimum lateral clearances at underpasses and retaining walls should include any provisions for the dynamic lateral deflection that the guardrail may require.

Additional information on vertical clearances is in section 3.3.

For more information on grade separation structures, see Chapter 10 of the *PGDHS (1)*.

10.4 INTERCHANGES

10.4.1 General

There are several basic interchange forms or geometric patterns of ramps for turning movements at a grade separation. Their application at a particular site is determined by the number of intersection legs, the expected volumes of through and turning movements, topography, culture, design controls, proper signing, and the designer's judgment.

The design and selection of an interchange type are influenced by many factors as described elsewhere in this chapter. Even though interchanges are, of necessity, designed to fit specific conditions and controls, the pattern of interchange ramps along a freeway should follow some degree of consistency. From the standpoint of driver expectancy, all interchanges should have one point of exit located in advance of the crossroad wherever practical. It is desirable to rearrange portions of the local street system in conjunction with freeway construction in order to achieve an effective overall plan of traffic service and community development.

Signing and operations are major considerations in the design of interchanges. Each design must be tested to determine if it can be signed properly for the smooth, safe flow of traffic. The need to simplify interchange design from the standpoint of signing and driver comprehension cannot be overstated.

From the standpoint of safety and in particular to prevent wrong-way movements, all freeway interchanges with non-access controlled highways should provide ramps to serve all basic directions. Drivers expect freeway-to-freeway interchanges to provide all directional movements. As a special case treatment, a specific freeway-to-freeway movement may be omitted if the turning traffic is minor and can be accommodated and given the same route signing via other nearby major state highways or other freeway facilities.

The basic interchange configurations are:

- Three-leg designs
- Four-leg designs
 - Ramps in one quadrant
 - Diamond interchanges
 - Diverging diamond interchanges (DDI)
 - Single-point urban interchanges (SPUI)
 - Cloverleafs
 - Partial cloverleaf ramp arrangements
 - Directional and semidirectional interchanges
- Other interchange configurations
 - Offset Interchanges
 - Combination Interchanges

CDOT and FHWA discourage the creation of partial interchanges and these should be avoided. See Chapter 10 of the *PGDHS (1)*.

10.5 GENERAL DESIGN CONSIDERATIONS

Except for accident data, all basic data listed under Chapter 9 is also required for interchange design. This includes:

- Design Speed
- Design Traffic Volumes
- Levels of Service
- Pavement and Shoulders
- Curbs
- Superelevation
- Grades
- Structures
- Horizontal and Vertical Clearance Sight Distance

Data relative to community service (community access needs), traffic (projected traffic volumes), physical (topographic), environmental (NEPA considerations), economic factors (potential right-of-way acquisition), and potential area development which may affect design, should be obtained prior to interchange design (context sensitive solutions). Specifically, the following information should be available:

- The location and standards (types) of existing and proposed local streets and highway development including types of traffic (access) control.
- Present and potential traffic circulation over the affected local roads or streets.
- Existing and proposed land use including such developments as shopping centers, recreational facilities, housing developments, schools, churches, hospitals, and other institutions.
- A traffic flow diagram (a schematic interchange layout) showing annual average daily traffic and design hourly volumes, as well as time of day (a.m. or p.m.), anticipated on the freeway ramps and any affected local roads or streets.
- The relationship with (distances to and from) adjacent interchanges.
- The location of major utilities and multi-modal facilities (e.g., railroads, transit, airports).

10.5.1 Determination of Interchange Configuration

The need to use interchanges may occur in the design of roadways of all functional classifications, as discussed under section 10.1.

In rural areas, the problem of interchange-type selection is solved on the basis of service demand. The predominant rural interchange type in use in Colorado is the diamond interchange.

A combination of directional, semi-directional, and loop ramps may be appropriate where turning volumes are high for some movements and low for others. When loop ramps are used in combination with direct and semi-direct ramp designs, it is desirable that the loops be arranged so that weaving sections will not be created.

A cloverleaf interchange is the minimum design that can be used at the intersection of two fully controlled access facilities or where left turns at-grade are prohibited. A cloverleaf interchange is adaptable in a rural environment where right-of-way is not prohibitive and weaving is minimal. In the decision process to use cloverleaf interchanges, careful attention should be given to the potential improvement in operational quality that would be realized if the design included collector-distributor roads on the major roadway.

Simple diamond interchanges are the most common type of interchange for the intersection of a major roadway with a minor facility. The capacity of a diamond interchange is limited by the capacity of the at-grade terminals of the ramps at the cross road. High through and turning volumes could preclude the use of a simple diamond unless signalization is used.

Diverging diamond interchanges (DDI) are a variation of conventional diamond interchanges. The DDI uses directional crossover intersections to shift traffic on the cross street to the left-hand side between the ramp terminals within the interchange. Crossing the through movements to the opposite side replaces left-turn conflicts with same-direction merge/diverge movements and eliminates the need for exclusive left-turn signal phases to and from the ramp terminals. All connections from the ramps to and from the cross street are joined outside of the cross-over intersections, and these connections can be controlled by two-phase signals, have stop or yield

control, or can be free flowing. In addition to the added safety benefits, DDI's typically have higher left-turn volume capacity and improved operations compared to conventional signalized diamond interchanges due to shorter cycle lengths, reduced time lost per cycle phase, reduced stops and delay, and shorter queue lengths.

Single-point urban interchanges (SPUI) is an interchange configuration that has all four turning movements controlled by a single traffic signal and the opposing left-turns operate to the left of each other, so their paths do not intersect. As a result, a major source of traffic conflict is eliminated, increasing the overall intersection efficiency and reducing the traffic signal phasing needed from four-phase to three-phase operation.

Partial cloverleaf designs may be appropriate where rights-of-way are not available in one or two quadrants or where one or two movements in the interchange are disproportionate to the others, especially when they require left turns across traffic. In the latter case, loop ramps may be utilized to accommodate the heavy left-turn volume.

Interchanges in rural areas are widely spaced and can be designed on an individual basis without any appreciable effect from other interchanges within the system.

The final configuration of an interchange may be determined by the need for route continuity, uniformity of exit patterns, single exits in advance of the separation structure, elimination of weaving on the main facility, signing potential, and available right-of-way.

Interchange-type determination in an urban environment requires considerable analysis of regional conditions so that the most practical interchange configurations can be developed.

10.5.2 Approaches to the Structure

See the *PGDHS (1)* Chapter 10.

10.5.2.1 Alignment, Profile, and Cross Section

Traffic passing through an interchange should be afforded the same degree of utility and safety as that given on the approaching highways. The design elements in the intersection area, therefore, should be consistent with those on the approaching highways, even though this may be difficult to attain. Preferably, the geometric design at the highway grade separation should be better than that for the approaching highways to counterbalance any possible sense of restriction caused by the structure. When it is practical to design only one of the intersecting roadways on a tangent with flat grades, it should be the major highway.

The general controls for horizontal and vertical alignment and their combination, as stated in Chapter 3, should be adhered to closely. Particular attention should be given to providing decision sight distance in situations where drivers must make complex or instantaneous decisions within interchanges.

The longitudinal distance needed for adequate design of a grade separation depends on the design speed, the roadway gradient, and the amount of rise or fall needed to achieve the separation. The amount of rise or fall needed will depend on the amount of vertical clearance needed in addition to the structure depth. The approximate distance needed to achieve a grade separation (assuming

flat terrain) can be determined using Figure 10-8 from the *PGDHS (1)* Chapter 10. This table will provide an approximate distance to achieve grade separation; however, a detailed design profile should be developed to confirm all design criteria have been met.

Typically, a 20- to 22-foot difference in elevation is needed at a grade separation of two highways for essential vertical clearance and structure depth. The same dimension generally applies to a highway undercrossing a railroad, but about 28 feet is needed for a highway overcrossing of a main-line railroad.

10.5.2.2 Sight Distance

Sight distance on the highways through a grade separation should be at least as long as that needed for stopping, and preferably longer. Where exits are involved, decision sight distance is preferred, although not always practical. Ramp terminals at crossroads should be treated as at-grade intersections and should be designed in accordance with Chapter 9.

10.5.3 Interchange Spacing

In general, the minimum interchange spacing should be one mile in urban areas and two miles in rural areas. In urban areas, spacing of less than one mile may be allowed with the use of auxiliary lanes, grade-separated ramps, or collector-distributor roads.

10.5.4 Uniformity of Interchange Patterns

Left-entrances are undesirable due to difficulties merging with high-speed through traffic. Except in highly special cases, all entrance and exit ramps should be on the right. To the extent practical, all interchanges along the freeway should be reasonably uniform in geometric layout and general appearance.

10.5.5 Route Continuity

See the *PGDHS (1)* Chapter 10.

10.5.6 Coordination of Lane Balance and Basic Number of Lanes

Fundamental to establishing the number and arrangement of lanes on a freeway is the designation of the basic number of lanes. A certain consistency should be maintained in the number of lanes provided along any route of arterial character. Thus the basic number of lanes is defined as a minimum number of lanes designated and maintained over a significant length of a route, irrespective of changes in traffic volume and lane-balance needs. Stating it another way, the basic number of lanes is a constant number of lanes assigned to a route, exclusive of auxiliary lanes.

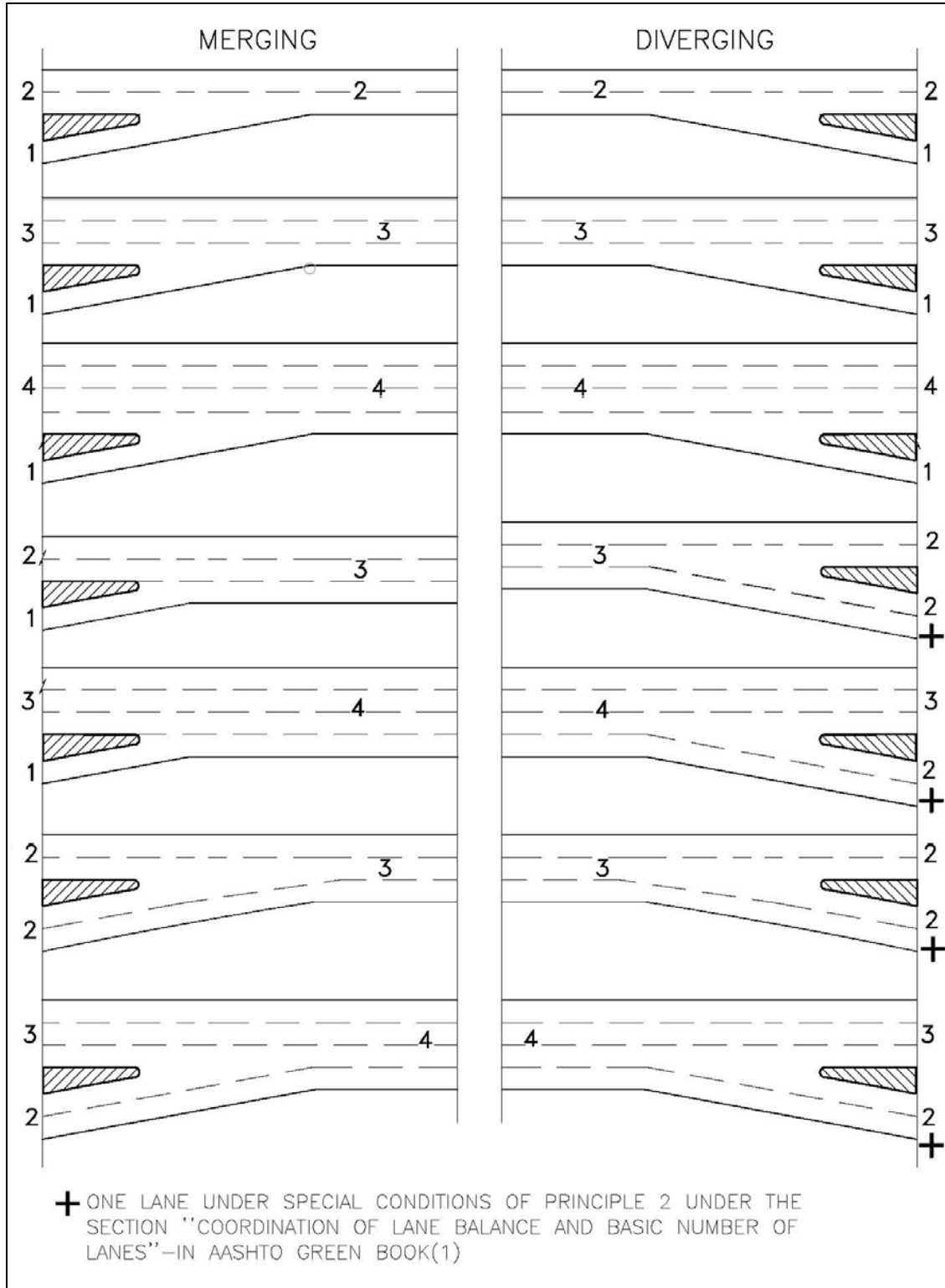

Figure 10-2 [Figure 10-50 of the PGDHS (1)] Typical Examples of Lane Balance

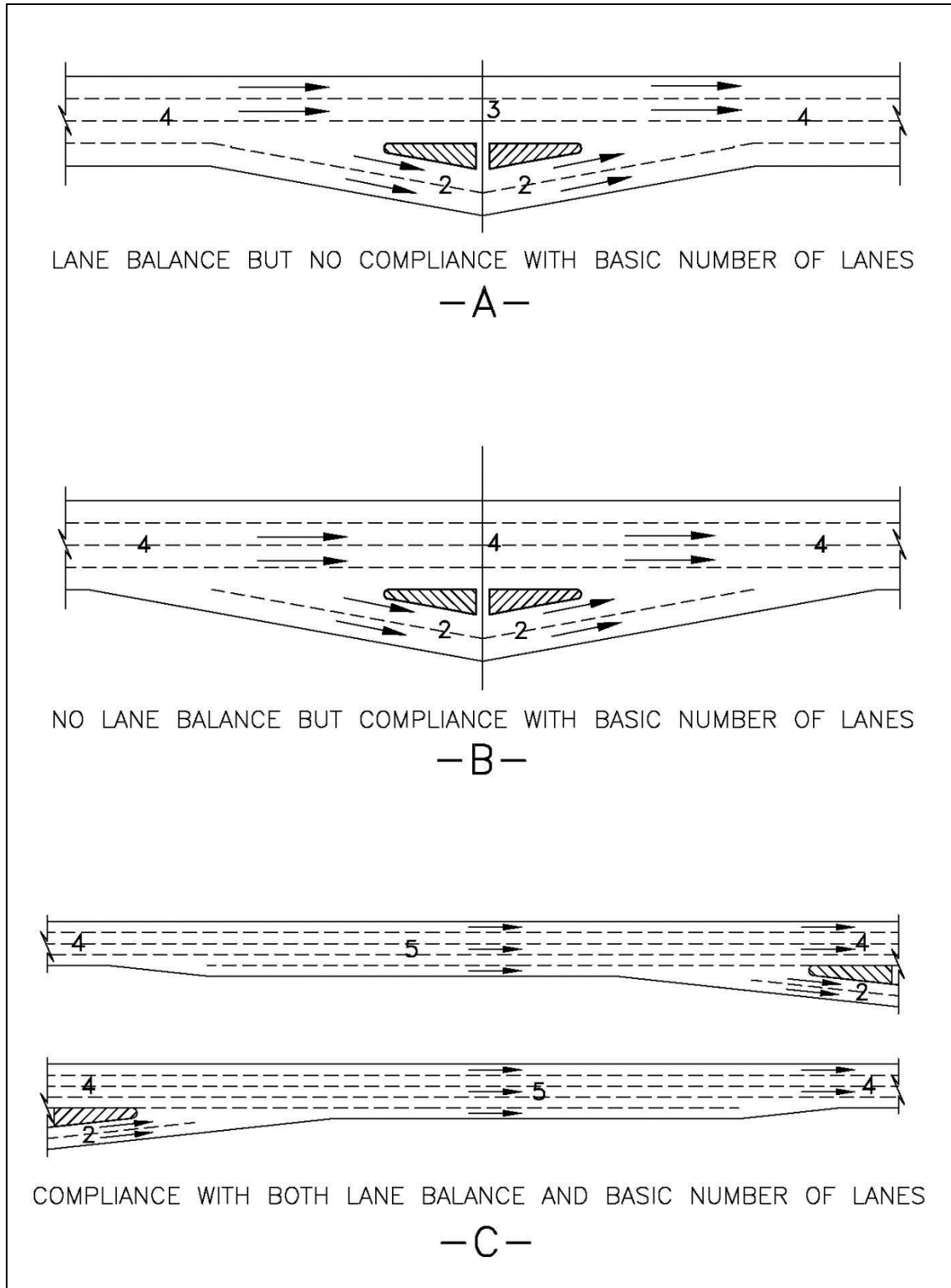

Figure 10-3 [Figure 10-51 of the PGDHS (1)] Coordination of Lane Balance and Basic Number of Lanes

10.5.7 Auxiliary Lanes

An auxiliary lane is defined as the portion of the roadway adjoining the traveled way for speed change, turning, storage for turning, weaving, truck climbing and other purposes supplementary to through-traffic movement. The width of an auxiliary lane should be equal to the through lanes. An auxiliary lane may be provided to comply with the concept of lane balance, to comply with capacity needs, or to accommodate speed changes, weaving, and maneuvering of entering and leaving traffic. Where auxiliary lanes are provided along freeway main lanes, the adjacent shoulder should desirably be 8 to 12 feet in width, with a minimum 6-foot wide shoulder considered.

10.5.8 Lane Reduction

If a basic lane or an auxiliary lane is to be dropped between interchanges, it should be accomplished at a distance of 2,000 to 3,000 feet from the previous interchange. The lane reduction should not be made so far downstream that motorists become accustomed to a number of lanes and are surprised by the reduction. The minimum taper rate should be 50:1, and the desirable taper rate is 70:1.

Left side lane reductions should be avoided because of generally higher speeds and less familiarity with left-side merges.

10.5.9 Weaving Sections

A weaving section is a length of one-way roadway where vehicles are crossing paths, changing lanes, or merging with through traffic as they enter or exit a freeway or collector-distributor road.

Weaving sections occur frequently along freeways and expressways in urban areas. Weaving sections are inherent to some interchanges, such as the cloverleaf and those with semi-direct connections. They are also found between ramps of closely spaced, successive interchanges.

Because considerable turbulence occurs throughout weaving sections, interchange designs that eliminate weaving or remove it from the main facility are desirable. Weaving sections may be eliminated from the main facility by the selection of interchange types that do not have weaving or by the incorporation of collector-distributor roads in the design.

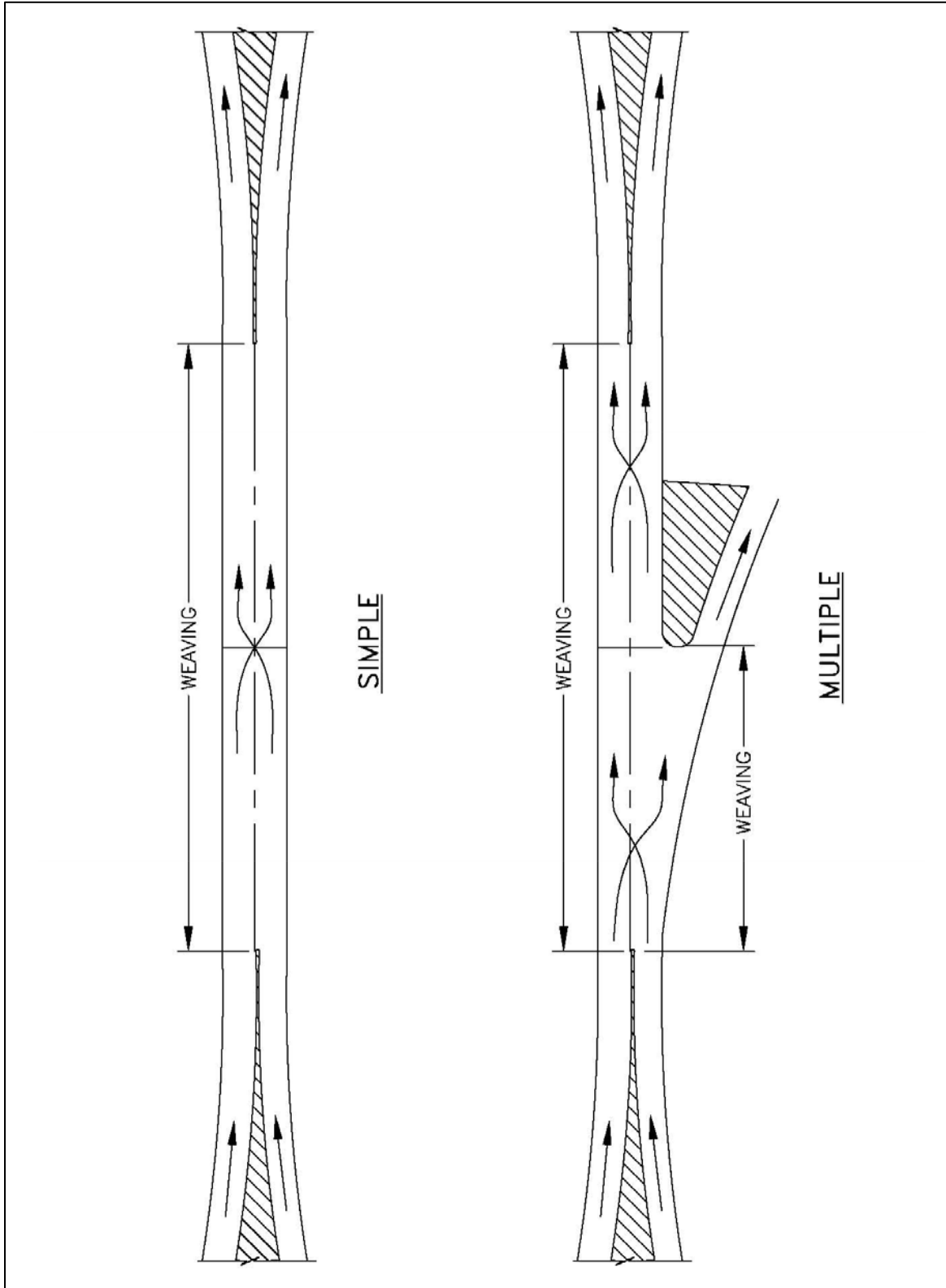

Figure 10-4A Types of Weaving Sections

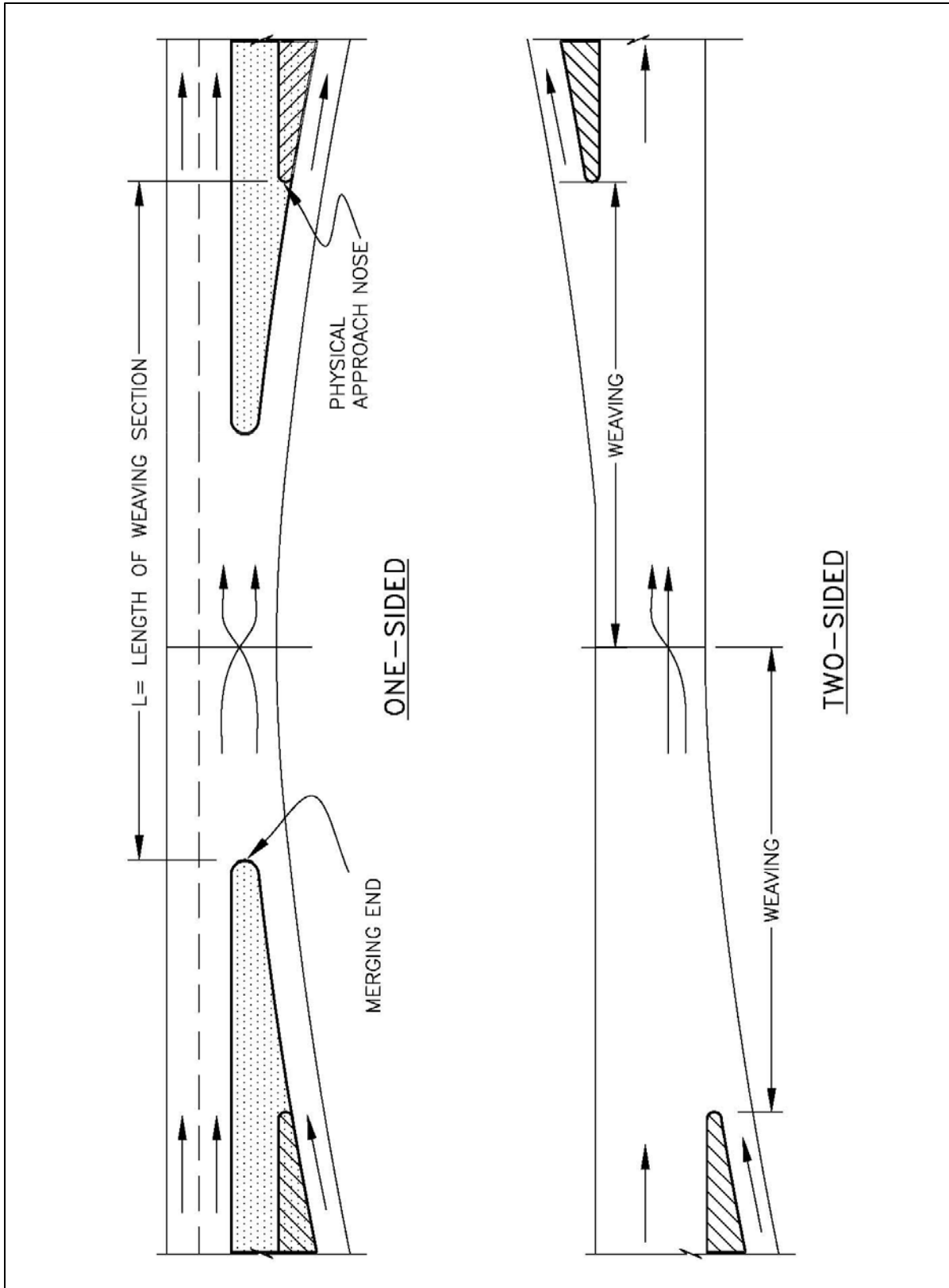

Figure 10-4B Types of Weaving Sections

A simple weaving section has an entrance at the upstream end and an exit at the downstream end. A multiple weaving section is characterized by more than one point of entry followed by one or more points of exit. For the various types of weaving situations, see Figures 10-4A and 10-4B.

The capacity of weaving sections may be seriously restricted unless adequate length and width are provided through the weaving section along with lane balance. See Chapter 2 of the *PGDHS (1)* for procedures for determining weaving lengths and widths.

Figures 10-5A and 10-5B give examples of balanced lane conditions. The established relation of factors used in the design of weaving sections is found in Chapter 13 of the Highway Capacity Manual (3). Weaving sections in urban areas should be designed for level of service C or D where possible. Weaving sections in rural areas should be designed for level of service B or C. Volume in equivalent passenger cars per hour (PCPH) is adjusted for freeway grade and truck volumes.

The Region Traffic and Safety Engineer should be consulted for difficult weaving analysis problems.

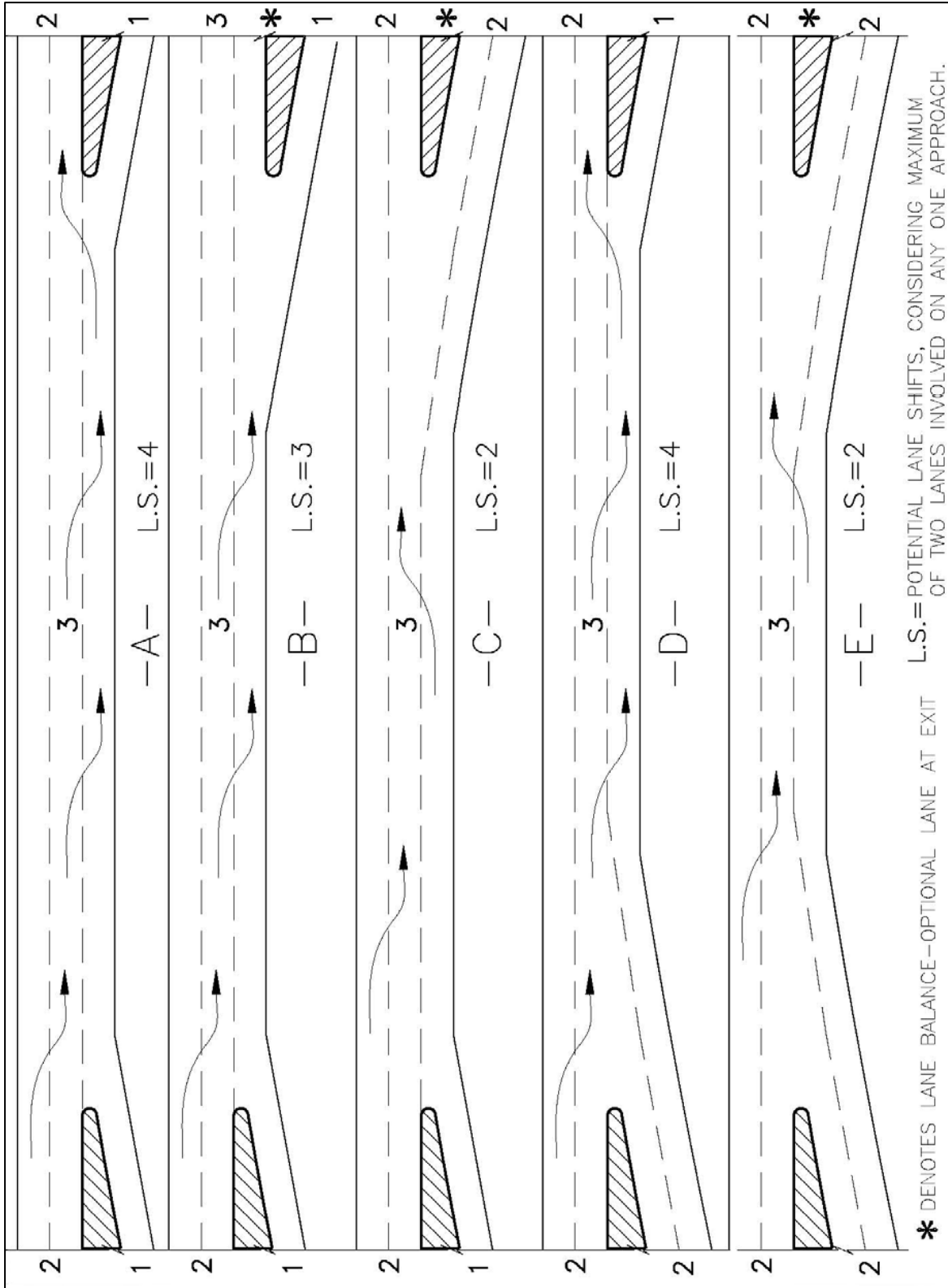

Figure 10-5A (CALTRANS 504. 7B (4)) Lane Configuration of Weaving Sections

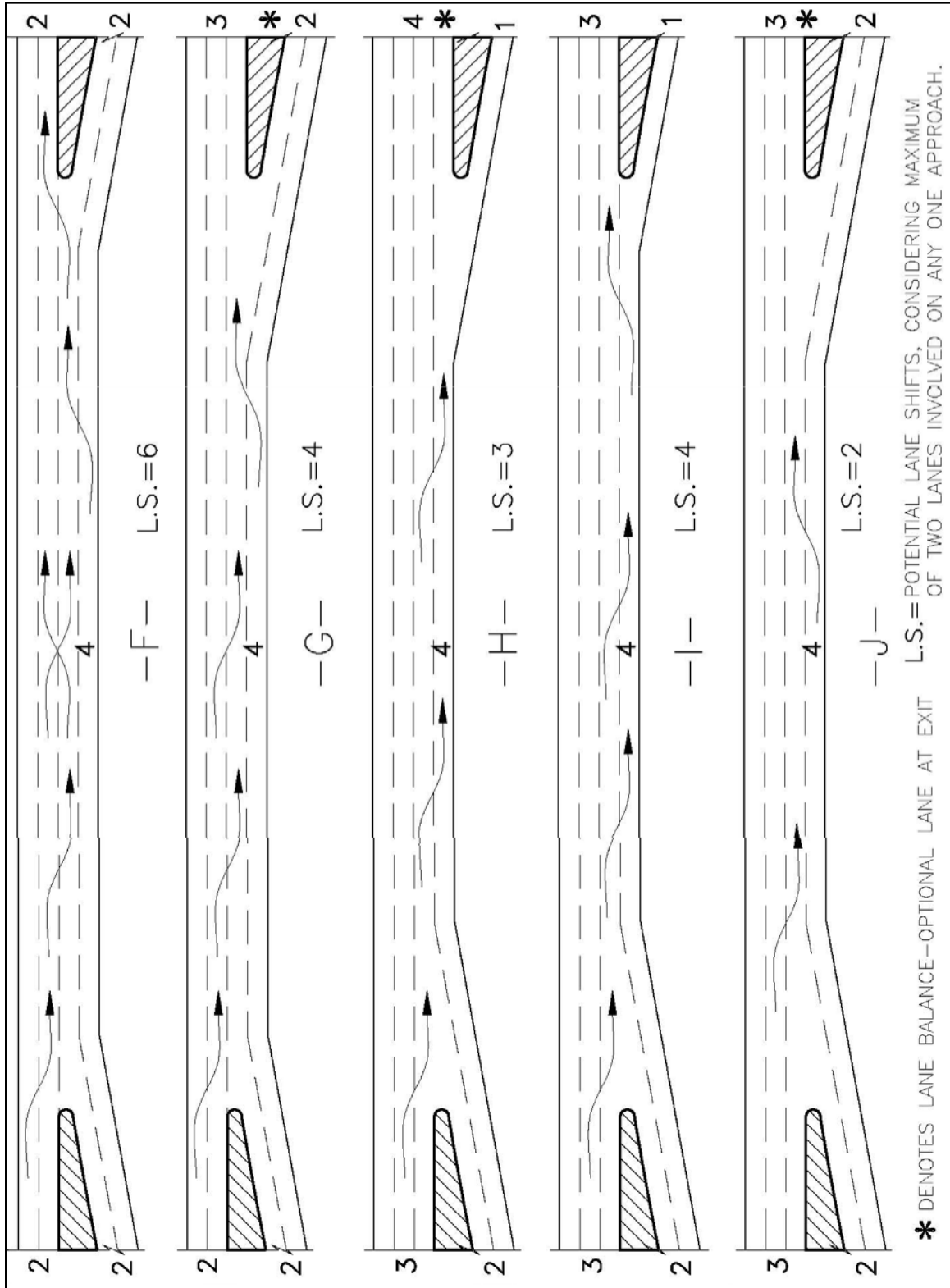

Figure 10-5B (CALTRANS 504. 7B (4)) Lane Configuration of Weaving Sections

10.5.10 Collector-Distributor Roads

Collector-distributor roads between two interchanges and continuous collector-distributor roads are discussed in Chapters 8 and 10 of the *PGDHS (1)*.

10.5.11 Two-Exit Versus Single-Exit Interchange Design

In general, interchanges that are designed with single exits are superior to those with two exits, especially if one of the exits is a loop ramp or the second exit is a loop ramp preceded by a loop entrance ramp. Whether used in conjunction with a full cloverleaf or with a partial cloverleaf interchange, the single-exit design may improve operational efficiency of the entire facility.

Additional information on this subject may be found in Chapter 10 of the *PGDHS (1)*.

10.5.12 Wrong-Way Entrances

Wrong-way entrance onto freeways and arterial streets is not a frequent occurrence, but it should be regarded as a serious problem whenever the likelihood exists, because each occurrence has such a high potential for culminating in a serious accident. This problem should be given special consideration at all stages of design. Most wrong-way entrances occur at freeway off ramps, at intersections at-grade along divided arterial streets, and at transitions from undivided to divided highways.

See *PGDHS (1)*, Chapter 10 for more information.

10.6 RAMPS

10.6.1 Types and Examples

The term "ramp" includes all types, arrangements, and sizes of turning roadways that connect two or more legs at an interchange. The components of a ramp are a terminal at each leg and a connecting road, usually with some curvature, and on a grade. Generally, the horizontal and vertical alignment standards of ramps are below that of the intersecting highway, but in some cases it may be equal. The basic types of ramps are:

- Diagonal
- One quadrant
- Loop and semidirect
- Outer connection
- Directional

For further information on these basic ramp types, see Chapter 10 of the *PGDHS (1)*.

10.6.2 General Ramp Design Considerations

10.6.2.1 Design Speed

Desirably, ramp design speeds should approximate the low-volume running speed on the intersecting highways. This design speed is not always practical, and lower design speeds may be selected, but they should not be less than the low-range presented in Table 10-1. Only those values for highway design speeds of at least 50 mph apply to freeway and expressway exits.

Consider the following when applying the values in Table 10-1 to various conditions and ramp types.

- **Portion of ramp to which design speed is applicable.** Values in Table 10-1 apply to the sharpest, or controlling, ramp curve, usually on the ramp proper. These speeds do not pertain to the ramp terminals, which should be properly transitioned and provided with speed-change facilities adequate for the highway speed involved.
- **Ramps for right turns.** An upper range value of design speed is often attainable on ramps for right turns, and a value between the upper and lower range is usually practical. The diamond ramp of a diagonal interchange may also be used for right turns. For these diagonal ramps, a value in the middle range is usually practical.
- **Loops.** Upper-range values of design speed generally are not attainable on loop ramps. Ramp design speeds above 30 mph for loops involve large areas, rarely available in urban areas, and long loops, which are costly and require left-turning drivers to travel a considerable extra distance. Minimum values usually control, but for highway design speeds of more than 50 mph, the loop design speed preferably should be no less than 25 mph (150-ft radius). If less restrictive conditions exist, the loop design speed and the radius may be increased.
- **Semi-direct connections.** Design speeds between the middle and upper ranges shown in Table 10-1 should be used. A design speed less than 30 mph should not be used. Generally, for short single lane ramps, a design speed greater than 50 mph is not practical. For two-lane ramps, values in the middle and upper ranges are appropriate.
- **Direct connections.** Design speeds between the middle and upper ranges shown in Table 10-1 should be used. The minimum design speed preferably should be 40 mph.
- **Different design speeds on intersecting highways.** The highway with the greater design speed should be the control in selecting the design speed for the ramp as a whole. However, the ramp design speed may vary, the portion of the ramp closer to the lower speed highway being designed for the lower speed. This variation in ramp design speed is particularly applicable where the ramp is on an upgrade from the higher speed highway to the lower speed highway.
- **At-grade terminals.** Where a ramp joins a major cross-road or street, forming an intersection at grade, Table 10-1 is not applicable to that portion of the ramp near the intersection because a stop sign or signal control is normally employed. This terminal design should be predicated on near-minimum turning conditions, as given in Chapter 9. In urban areas, where the land adjacent to the interchange is developed commercially, provisions for pedestrian movements through the interchange area should be considered.

If lower range design speeds are used for ramps, consideration should be made for additional acceleration/deceleration length and warning signs.

Range	Ramp Design Speed (mph) For Particular Highway Design Speed (mph)									
	30	35	40	45	50	55	60	65	70	75
Upper Range (85%*)	25	30	35	40	45	48	50	55	60	65
Middle range (70%*)	20	25	30	33	35	40	45	45	50	55
Lower Range (50%*)	15	18	20	23	25	28	30	30	35	40
Corresponding Minimum Radius (ft)	See Table 3-7 in the <i>PGDHS (1)</i>									
* percentage of highway design speed										

Table 10-1 [Table 10-1 of the *PGDHS (1)*] Guide Values for Ramp Design Speed as Related to Highway Design Speed

10.6.2.2 Curvature

See the *PGDHS (1)*, Chapter 10.

10.6.3 Stopping Sight Distance

Stopping sight distance along a ramp should be at least as great as the design stopping sight distance. Stopping sight distance consistent with the design speed as shown in Table 3-1 shall be provided on each ramp of an interchange. Sight distance for passing is not required. There should be a clear view of the entire exit terminal, including the exit nose and a section of the ramp pavement beyond the gore. Decision sight distance should be provided when drivers must make complex or instantaneous decisions within interchanges.

If the exit terminal is signalized or stop controlled, design the terminal as an at-grade intersection and refer to Chapter 9 of this guide or the *PGDHS (1)*.

10.6.4 Ramp Profiles

Ramp profiles generally consist of a section of tangent grade between the vertical curves. The tangent or controlling grade on ramps should be as flat as feasible, but may be steeper than on the through facilities. Adequate sight distance is more important than a specific gradient control and should be favored in design. Consider the following:

- It is desirable that upgrades on ramps with a design speed of 45 to 50 mph be limited to 3 to 5 percent.
- Upgrades on ramps having a design speed of 40 mph should be limited to 4 to 6 percent
- Upgrades on ramps having design speeds of 25 to 30 mph should be limited to 5 to 7 percent.
- Upgrades on ramps having a design speed of 15 to 25 mph should be limited to 6 to 8 percent.
- Downgrades preferably should be limited to 3 to 4 percent on ramps having sharp horizontal curvature and significant heavy truck or bus traffic. Short upgrades of as much as 5 percent do not unduly interfere with truck and bus operation.

- Ramps with high design speeds or those joining high-speed highways generally should have flatter grades than ramps with low design speeds or minor, light-volume ramps.

Usually ramp profiles assume the shape of the letter "S," with a sag vertical curve at the lower end and a crest vertical curve at the upper end. Additional vertical curves may be necessary, particularly on ramps that cross under or over other roadways. Where a crest or sag vertical curve extends onto a ramp terminal, the length of the curve should be determined by using a design speed intermediate between those on the ramp and the highway. Minimum lengths of crest vertical curves on ramps are based on stopping sight distance as shown in Chapter 3 of this Guide.

The design controls for sag vertical curves differ from those for crests; therefore, separate design values are needed. Minimum values of sag vertical curves are based on values of K and stopping sight distance as shown in Chapter 3 of this Guide.

Profiles of ramp terminals should be designed in association with horizontal curves to avoid sight restrictions that will adversely affect operations. At an exit onto a ramp on a descending grade, a horizontal curve ahead should not appear suddenly to a driver using the ramp. Instead, the initial crest vertical curve should be made longer and sight distance over it increased so that the beginning and the direction of the horizontal curve are obvious to the driver in time for safe operations. At an entrance terminal from a ramp on an ascending grade, the portion of the ramp and its terminal intended for acceleration should closely parallel the through lane profile to permit entering drivers to have a clear view ahead, to the side, and to the rear on the through road.

A "platform" area should be provided at the at-grade terminal, approach nose, and merging end of a ramp. This platform should be an area on which the profile and cross-slope do not greatly differ from that of the through traffic lane. The length of this platform should be determined from the type of traffic control and the capacity at the terminal, but is typically at least 200 feet. For further discussion, see Chapter 9, Figure 9-44 through 9-47, of the *PGDHS (1)*.

In addition, an analysis of each alternate preliminary plan should be made for aesthetics. A ramp design that meets all design requirements may have objectionable features which can be eliminated with a minimum of change. Examples of objectionable features are:

- Humps or rolls in a ramp profile
- Short reverse curvature in ramp alignment

Where the main roadway in level terrain is taken over a cross road, an undesirable hump may appear in the ramp profile unless the ramp exit splits away from the main roadway before the main roadway begins to rise.

Short reverse curvature introduced in ramp alignment to obtain separation of ramp and main roadway in a short distance should be avoided, as it is impossible to obtain proper superelevation of the curves without an intervening length of tangent for superelevation transitions between the reversing curves.

10.6.5 Superelevation and Cross Slope

Consider the following for cross slope design on ramps:

- Superelevation as related to curvature and design speed on ramps is given in CDOT Standard Plans – M & S Standards (5). Where drainage impacts to adjacent property or the frequency of slow moving vehicles are important considerations, the superelevation rates and corresponding radii in Figure 3-16 of the *PGDHS (1)* can be used.
- The cross slope on portions of ramps on tangent normally should be sloped one way at a practical rate ranging from 1.5 to 2 percent for high-type pavements.
- In general the rate of change in cross slope in the superelevation runoff section should be based on the maximum relative gradients listed in Table 3-15 of the *PGDHS (1)*. The values listed in this table are applicable to single lane rotation. The adjustment factors b_w listed in Table 3-16 of the *PGDHS (1)* allow for slight increases in the effective gradient for wider road widths. The effective maximum relative gradients (equal to $\Delta \div b_w$) applicable to a range of roadway widths are listed in Table 9-19 of the *PGDHS (1)*. The superelevation development is started or ended along the auxiliary lane of the ramp terminal. Alternate profile lines for both edges should be studied to ensure that all profiles match the control points and that no unsightly bumps and dips are inadvertently developed. Spline profiles are very useful in developing smooth lane/shoulder edges.
- Another important control in developing superelevation along the ramp terminal is that of the crossover crown line at the edge of the through traffic lane. The maximum algebraic difference in cross slope between the auxiliary lane and the adjacent through lane is shown in Table 10-2.
- Three segments of a ramp should be analyzed to determine superelevation rates that would be compatible with the design speed and the configuration of the ramp. The exit terminal, the ramp proper, and the entrance terminal should be studied in combination to ascertain the appropriate design speed and superelevation rates.
- Drainage and icing issues should be considered when transitioning between superelevations.

Design Speed of Exit or Entrance Curve (mph)	Maximum Algebraic Difference in Cross Slope at Crossover Line (%)
20 and under	5.0 to 8.0
25 and 30	5.0 to 6.0
35 and over	4.0 to 5.0

Table 10-2 [Table 9-20 of the *PGDHS (1)*] Maximum Algebraic Difference in Pavement Cross Slope at Turning Roadway Terminals

10.7 INTERCHANGE DESIGN CRITERIA

10.7.1 General

The following design criteria pertain to design elements of all interchanges. Geometric and structure criteria for the design of the through highway within the interchange area are presented elsewhere in this Guide. Ramp design criteria are developed in section 10.6.

Interchanges are composed of a combination of channelization elements. For this reason, design criteria pertaining to intersections at-grade (see Chapter 9) will not be repeated here; only additional design criteria unique to interchanges will be given.

10.7.2 Sight Distance

Sight distance on the highways through a grade separation or interchange should be at least as long as that required for stopping and preferably longer. Where exits are involved, decision sight distance is preferred, although not always practical. Design of the vertical alignment is the same as that at any other point on the highway. Ramp terminals at crossroads should be treated as at-grade intersections and should be designed in accordance with Chapter 9 of the *PGDHS (1)*, with specific attention to intersection sight distance.

At underpasses, care should be taken to ensure that the vertical sight distance is not limited by the bottom of the girders of the overpassing structure. This may occur at locations where the highway is depressed for a short distance and the maximum grades and minimum sag vertical curves are used under the structure. Particular attention should be given to trucks, where the sight distance will be further limited due to the higher driver's height of eye.

The horizontal sight distance limitations of piers and abutments at curves usually present a more difficult problem than that of vertical limitations. With curvature of the maximum degree for a given design speed, the normal lateral offset of piers or abutments of underpasses does not provide the minimum stopping sight distance.

Similarly, on overpasses with the sharpest curvature for the design speed, sight deficiencies result from the usual practical shoulder offset to the bridge rails. This factor emphasizes the need for use of below-maximum curvature on highways through interchanges. If sufficiently flat curvature cannot be used, the clearances to abutments, piers, or bridge rails should be increased as necessary to obtain the proper sight distance even though it is necessary to increase span lengths or structure widths.

Normally, no more than 12 feet will be allowed on overpass structures for the lateral offset from the lane line to the bridge rail. Exceptions will be made for future lanes or for construction phasing requirements when replacing existing structures. See subsection 10.3 on lateral clearances on structures for additional information on this subject.

10.7.3 Sight Distance to Exit Nose

There should be a clear view of the entire exit ramp terminal, including the exit nose and a section of the ramp pavement beyond the gore. The sight distance on a freeway preceding the approach nose of an exit ramp should exceed the minimum for the through traffic design speed, desirably

by 25 percent or more. In addition, the minimum sight triangle as shown in Figures 9- 5A and 5B, 10-6 and 10-7 should be provided between vehicles approaching the ramp intersections. For considerations of longer sight distances, refer to Chapter 3.

Decision sight distance given in Chapter 3 is preferred at all freeway exits and branch connections. In all cases, sight distance is measured to the center of the ramp lane right of the nose. See Figures 9-5A and 9-5B in this Guide.

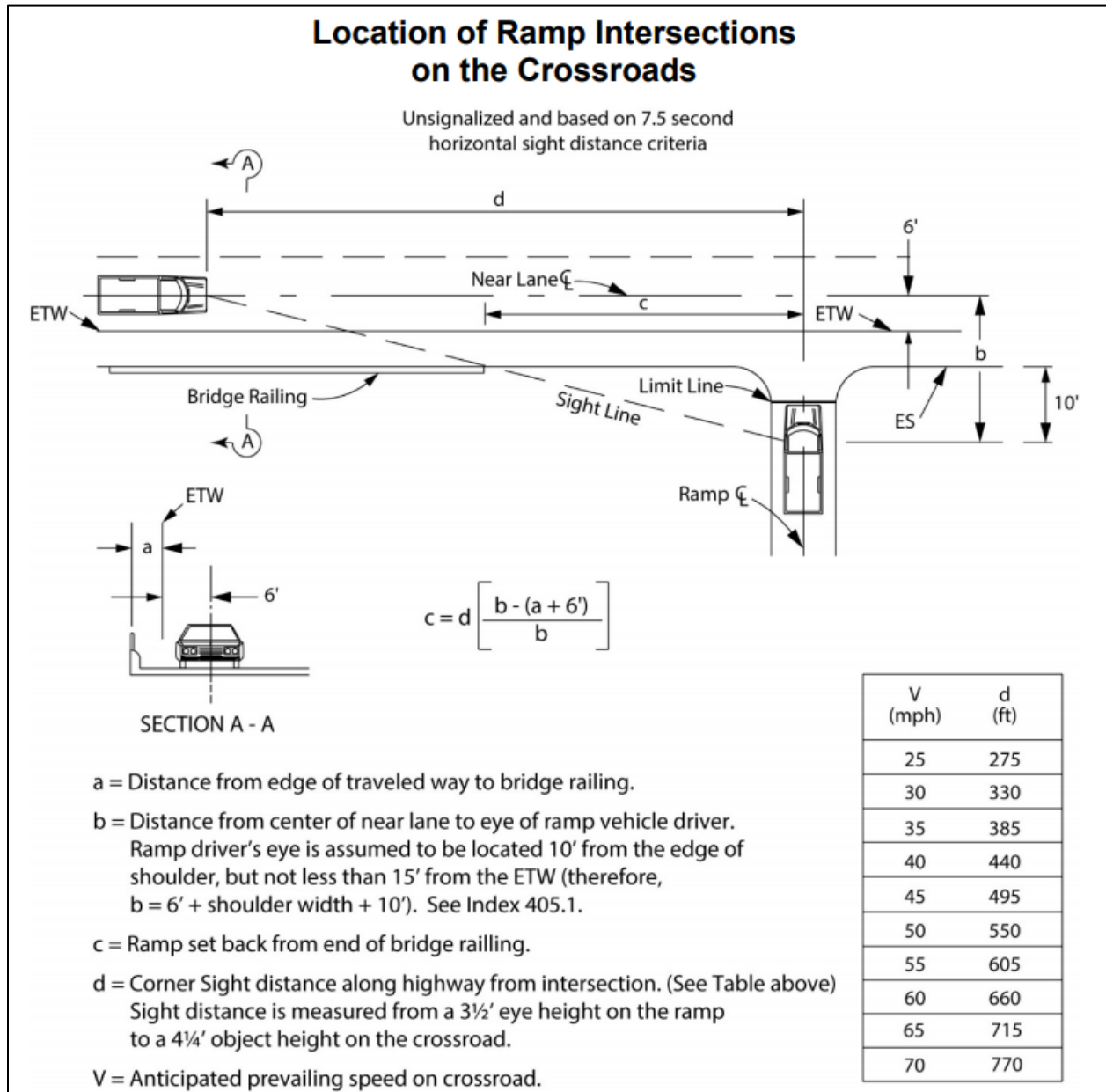

Figure 10-6 (CALTRANS 504.3I (4)) Location of Ramp Intersections on the Cross Road

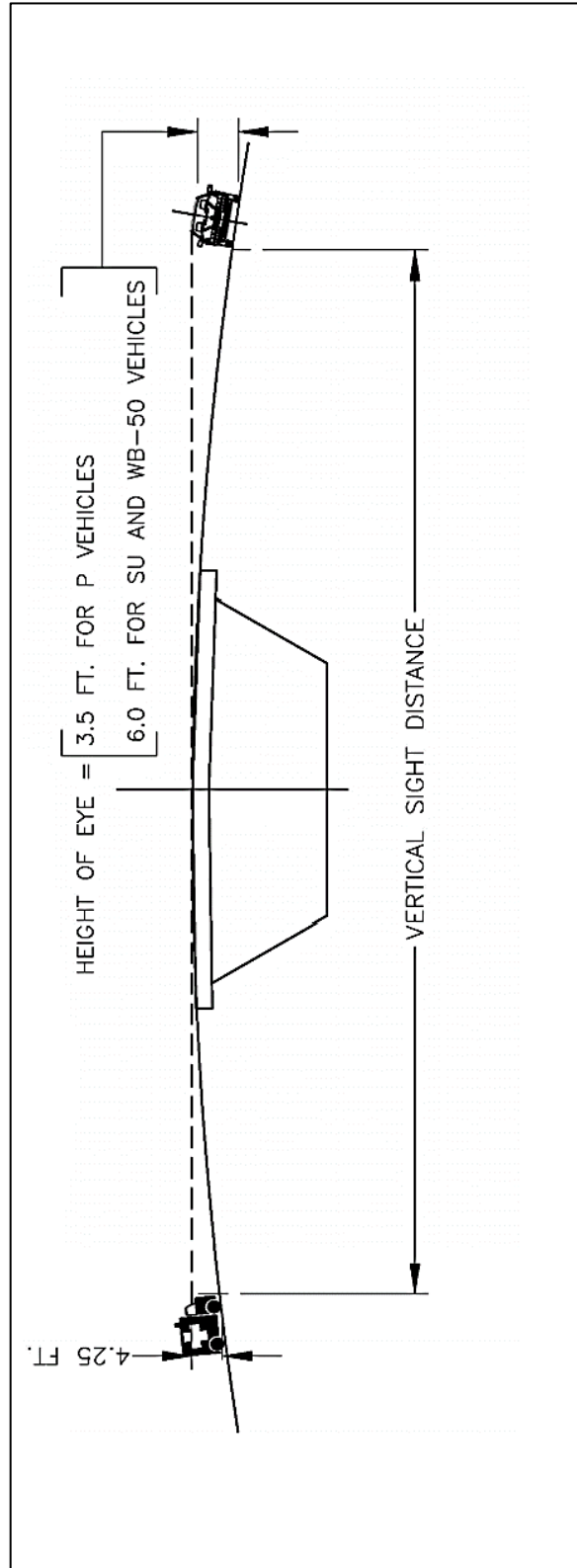

Figure 10-7 Measurement of Sight Distance at Ramp Terminals with Stop Controls

10.7.4 Gores

The term "gore" indicates an area downstream from the shoulder intersection points as illustrated in Figure 10-8.

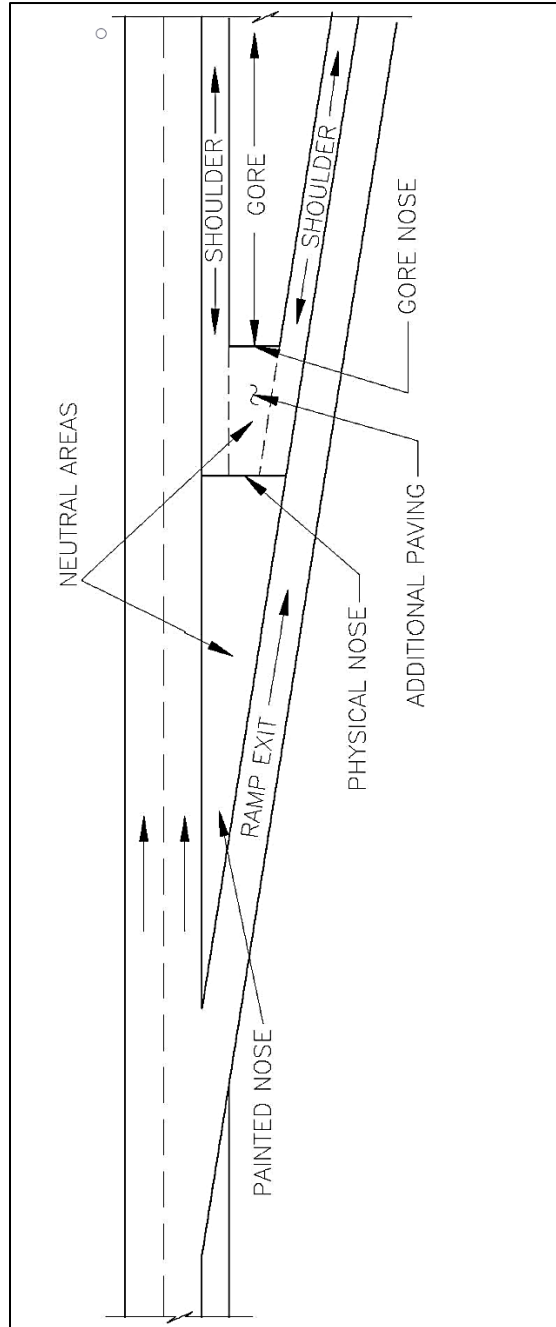

Figure 10-8 [Figure 10-61 of the PGDHS (1)] Typical Gore Area Characteristic

(This is a conceptual figure. See Figures 10-16 A and B for more specific details.)

It is the decision point area that must be clearly seen and understood by approaching drivers. Further, the separating ramp roadway not only must be clearly evident but also must be of geometric shape to fit the likely speeds at that point. In a series of interchanges along a freeway the gores should be uniform and have the same appearance to drivers.

As a general rule, the width at the gore nose is typically between 20 and 30 feet, including paved shoulders, measured between the traveled way of the main line and that of the ramp. This dimension may be increased if the ramp roadway curves away from the freeway immediately beyond the gore nose or if speeds in excess of 60 mph are expected to be common. See Figures 10-12 to 10-15 for additional details of gore dimensions.

The entire triangular area should be striped to delineate the proper paths on each side and to assist the driver in identifying the gore area.

It is imperative that gore areas and the areas beyond provide clear recovery area for out-of-control vehicles or for drivers who decide at the last second not to exit. Additional paving shall be placed in the neutral area between the physical nose and the gore nose to allow drivers to recover after starting their exit maneuver (see Figures 10-14 and 10-15).

The gore area and the unpaved area beyond should be kept as free of obstructions as possible to provide a clear recovery area. The unpaved area beyond the nose should be graded as nearly level with the roadways as is practicable so that vehicles inadvertently entering will not be overturned or abruptly stopped by steep slopes. Heavy sign supports, street light standards, and roadway structure supports should be kept well out of the graded gore area. Yielding or breakaway type supports should be used for the standard exit sign, and concrete footings, where used, should be kept flush with adjoining ground level. If non-yielding obstructions are unavoidable in the gore area, impact attenuators should be considered.

Although the term "gore" generally refers to the area between a through roadway and an exit ramp, the term sometimes is also used to refer to the similar area between a through roadway and a converging entrance ramp. At an entrance terminal, the point of convergence (beginning of all paved area) is defined as the "merging end." In shape, layout, and extent, the triangular maneuver area at an entrance terminal is much like that at an exit. However, it points downstream and separates traffic streams already in lanes, thereby being less of a decision area. The width at the base of the paved triangular area is narrower, usually being limited to the sum of the shoulder widths on the ramp and freeway plus a narrow physical nose 4 to 8 feet wide.

Figure 10-9 diagrammatically details a typical gore design for an entrance ramp.

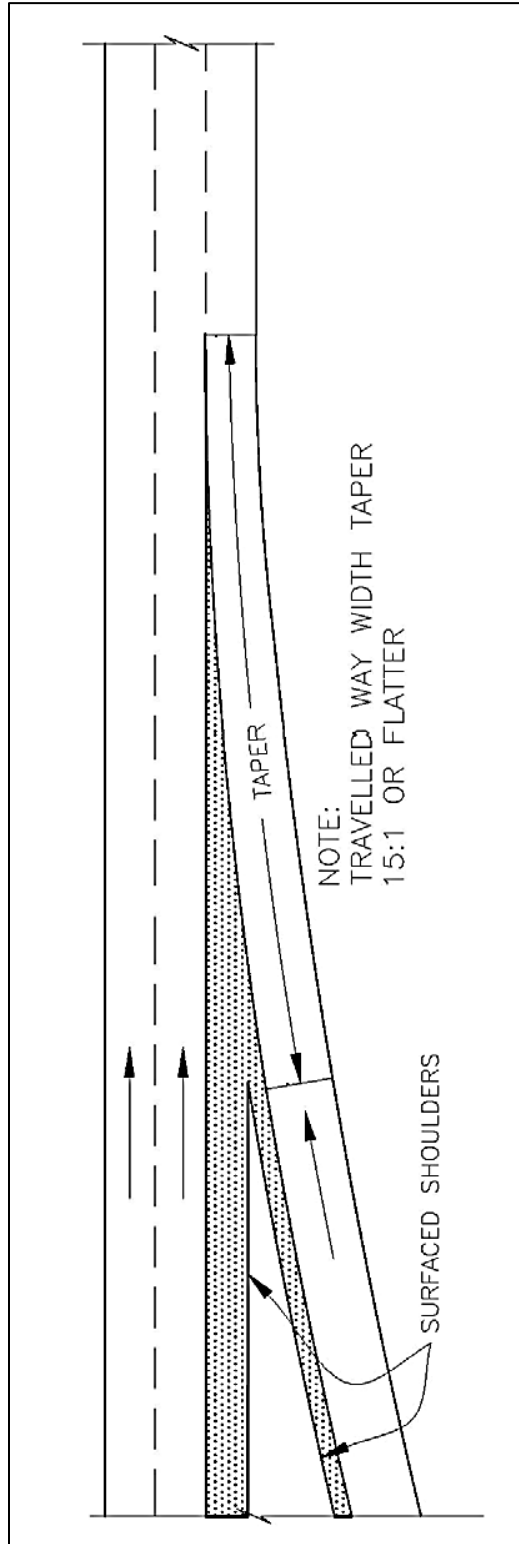

Figure 10-9 [Figure 10-63 of the *PGDHS* (1)] Traveled Way Narrowing on Entrance Ramps

10.7.5 Ramp Pavement Widths

10.7.5.1 Width and Cross Section

Ramp pavement widths are governed by the type of operation, curvature, volume, and type of traffic. It should be noted that the roadway width for a turning roadway, as distinct from pavement width, includes shoulders or equivalent clearance outside the edges of pavement. See Chapter 3 for additional information on the treatments at the edge of pavement. Design widths of ramp pavements for three general design traffic conditions are given in Table 9-1 “Design Widths of Pavements for Turning Roadways”, of this guide.

10.7.5.2 Shoulders and Lateral Clearances

Design values for shoulders and lateral clearances on the ramps are as follows:

- When paved shoulders are provided on ramps, they should have a uniform width for the full length of ramp. For one-way operation, the sum of the right and left shoulder widths should not exceed 10 to 12 feet. A paved shoulder width of 2 to 4 feet is desirable on the left with the remaining width of 8 to 10 feet used for the paved right shoulder.
- The ramp traveled way widths from Table 3-29 of the *PGDHS (1)* for Case II and Case III should be modified when paved shoulders are provided on the ramp. The ramp traveled-way width for Case II should be reduced by the total width of both right and left shoulders. However, in no case should the ramp traveled way be less than needed for Case I. For example, with condition C and a 400-foot radius, the Case II ramp traveled-way width without shoulders is 22 feet. If a 2-foot left shoulder and an 8-foot right shoulder are provided, the minimum ramp traveled-way width should be 16 feet.
- Directional ramps with a design speed over 40 mph should have a paved right shoulder width of 8 to 10 feet and a paved left shoulder width of 1 to 6 feet.
- For freeway ramp terminals where the ramp shoulder is narrower than the freeway shoulder, the paved shoulder width of the through lane should be carried into the exit terminal. It should also begin with the entrance terminal, with the transition to the narrower ramp shoulder accomplished gracefully on the ramp end of the terminal. Abrupt changes should be avoided.
- Ramps should have a lateral clearance on the right outside of the edge of the traveled way at least 6 feet, and preferably, 8 to 10 feet, and a lateral clearance on the left of at least 4 feet beyond the edge of traveled way.
- Where ramps pass under structures, the total roadway width should be carried through the structure. Desirably, structural supports should be located beyond the clear zone. As a minimum, structural supports should be at least 4 feet beyond the edge of paved shoulder. The *AASHTO Roadside Design Guide (6)* provides guidance on the clear zone and the use of roadside barriers.
- Ramps on overpasses should have the full approach roadway width carried over the structure.
- Edge lines or some type of color or texture differentiation between the traveled way and shoulder is desirable.

10.7.6 Ramp Terminals

The terminal of the ramp is that portion adjacent to the through traveled way, including speed-change lanes, tapers, and islands. Ramp terminals may be the at-grade type as at the crossroad

terminal of diamond or partial cloverleaf interchanges, or the free-flow type where ramp traffic merges with or diverges from high-speed through traffic at flat angles. Design elements for the former type are discussed in Chapter 9, and those for the latter type are discussed in the following sections.

Terminals are further classified according to the number of lanes on the ramp terminal, either single or multilane, and according to the configuration of the speed-change lane, either taper type or parallel type.

10.7.6.1 Right-Hand Entrances and Exits

All freeway entrances and exits shall connect to the right of through traffic. Right-hand entrances and exits operate fairly well and do not violate the concept of driver expectancy. Left-hand entrances and exits may be considered in only unusual circumstances and the design engineer should use extreme care in selecting and designing any left-hand entrances and exits.

10.7.6.2 Left-Hand Entrances and Exits

Left-hand entrances and exits are contrary to the concept of driver expectancy when intermixed with right-hand entrances and exits.

Extreme care should be exercised to avoid left-hand entrances and exits in the design of interchanges. Even in the case of major forks and branch connections, the less significant roadway should exit and enter on the right. See the discussion on route continuity in Chapter 10 of the *PGDHS (1)*.

Left-side terminals break up the uniformity of interchange patterns and in general create hesitant operation on the through roadways.

Left-hand entrances and exits are considered satisfactory for collector-distributor roads; however, their use on high-speed, free-flow ramp terminals is not recommended. Because left-hand entrances and exits are contrary to driver expectancy, special attention should be given to weaving from adjacent right-hand entrances, signing, and the provision for decision sight distance in order to alert the driver that an unusual situation exists.

10.7.6.3 Terminal Location and Sight Distance

Freeway entrances and exits should be located on tangent sections wherever possible to provide maximum sight distance and optimum traffic operations. Entrances and exits at left-hand curves, particularly curves requiring superelevation, should be avoided whenever possible. Ramp terminal spacing shall conform to Figure 10-10 wherever practical.

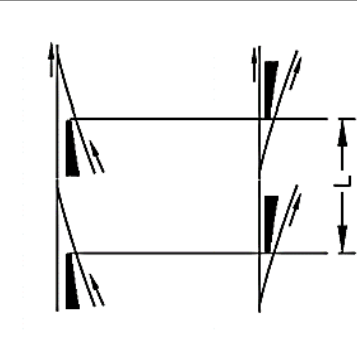
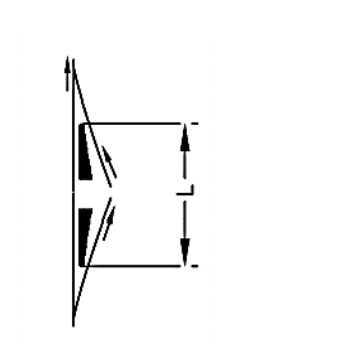
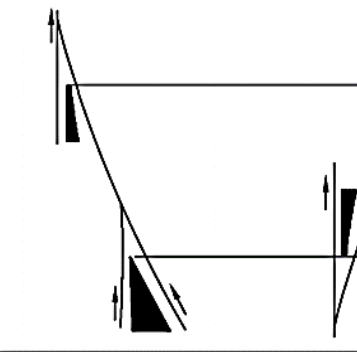
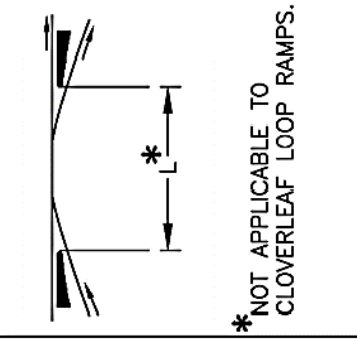
EN-EN OR EX-EX	EX-EN	TURNING ROADWAYS	EN-EX (WEAVING)
			 <p data-bbox="638 195 703 531">* NOT APPLICABLE TO CLOVERLEAF LOOP RAMP.</p>
FULL FREEWAY	FULL FREEWAY	SYSTEM INTERCHANGE	SYSTEM TO SERVICE INTERCHANGE
		CDR OR FDR	FULL FREeway OR CDR OR FDR
MINIMUM LENGTHS MEASURED BETWEEN SUCCESSIVE RAMP TERMINALS (FEET)			
1000	500	800	2000 1600 1600 1000

Abbreviations	
EN = Entrance	CDR = Collector- Distributor Road
EX = Exit	FDR = Freeway Distributor Road

Figure 10-10 [Figure 10-68 of the PGDHS (1)] Recommended Minimum Ramp Terminal Spacing

10.7.6.4 Speed-Change Lanes

Two general forms of speed change lanes are: (1) the taper and (2) the parallel type. The taper type provides a direct entry or exit at a flat angle; whereas the parallel type has an added lane for changing speed. When conditions allow, CDOT prefers the parallel type.

Speed-change lanes are provided at all ramp connections. See Tables 10-3 and 10-4 for minimum lengths. Table 10-5 gives corrections to be applied when the speed-change lane grades are 3 percent or steeper.

Highway Design Speed, mph (V)	Speed Reached, mph (V _A)	L = Deceleration Length, (ft) for Design Speed of Exit Curve, mph (V')								
		Stop Condition	15	20	25	30	35	40	45	50
		For Average Running Speed on Exit Curve, mph (V' _A)								
		0	14	18	22	26	30	36	40	44
30	28	235	200	170	140	---	---	---	---	---
35	32	280	250	210	185	150	---	---	---	---
40	36	320	295	265	235	185	155	---	---	---
45	40	385	350	325	295	250	220	---	---	---
50	44	435	405	385	355	315	285	225	175	---
55	48	480	455	440	410	380	350	285	235	---
60	52	530	500	480	460	430	405	350	300	240
65	55	570	540	520	500	470	440	390	340	280
70	58	615	590	570	550	520	490	440	390	340
75	61	660	635	620	600	575	535	490	440	390

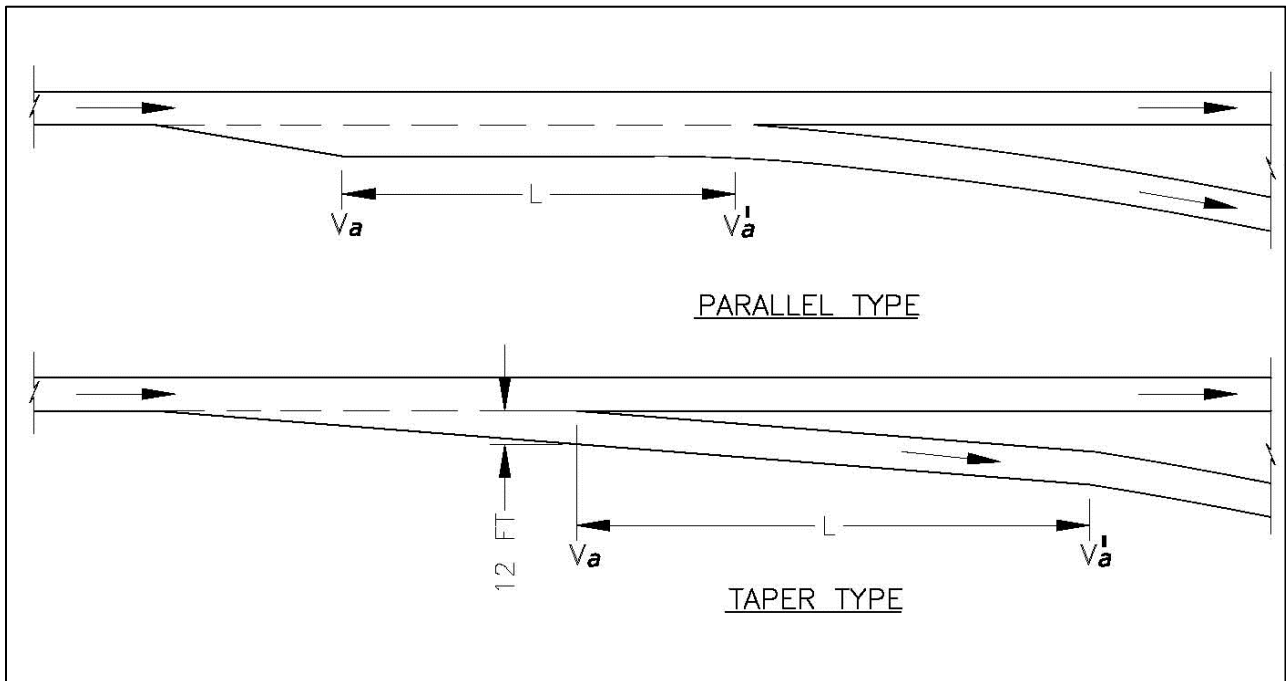

Table 10-3 [Table 10-5 of the PGDHS (1)] Minimum Deceleration Lengths for Exit Terminals With Flat Grades of 2 Percent or Less

Highway Design Speed, mph (V)	Speed Reached, mph (V_A)	L = Acceleration Length, (ft) for Design Speed of Entrance Curve, mph								
		Stop Condition	15	20	25	30	35	40	45	50
		and initial speed, mph (V'_A)								
		0	14	18	22	26	30	36	40	44
30	23	180	140	---	---	---	---	---	---	---
35	27	280	220	160	---	---	---	---	---	---
40	31	360	300	270	210	120	---	---	---	---
45	35	560	490	440	380	280	160	---	---	---
50	39	720	660	610	550	450	350	130	---	---
55	43	960	900	810	780	670	550	320	150	---
60	47	1200	1140	1100	1020	910	800	550	420	180
65	50	1410	1350	1310	1220	1120	1000	770	600	370
70	53	1620	1560	1520	1420	1350	1230	1000	820	580
75	55	1790	1730	1630	1580	1510	1420	1160	1040	780

Uniform 50:1 to 70:1 tapers are recommended where lengths of acceleration lanes exceed 1,300 ft.

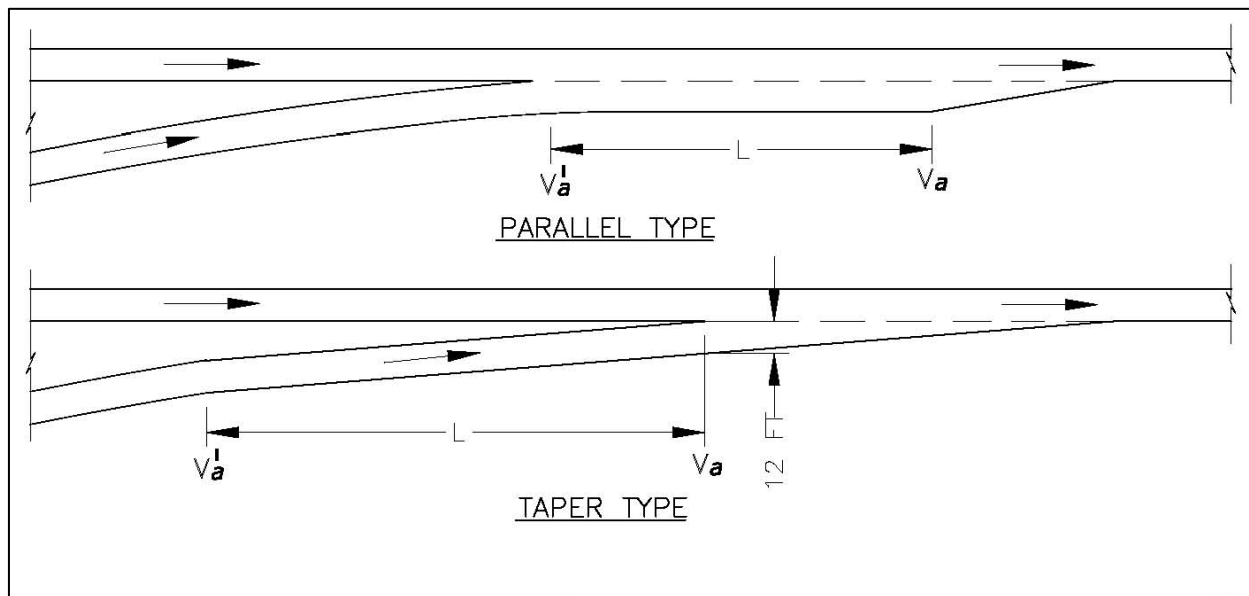
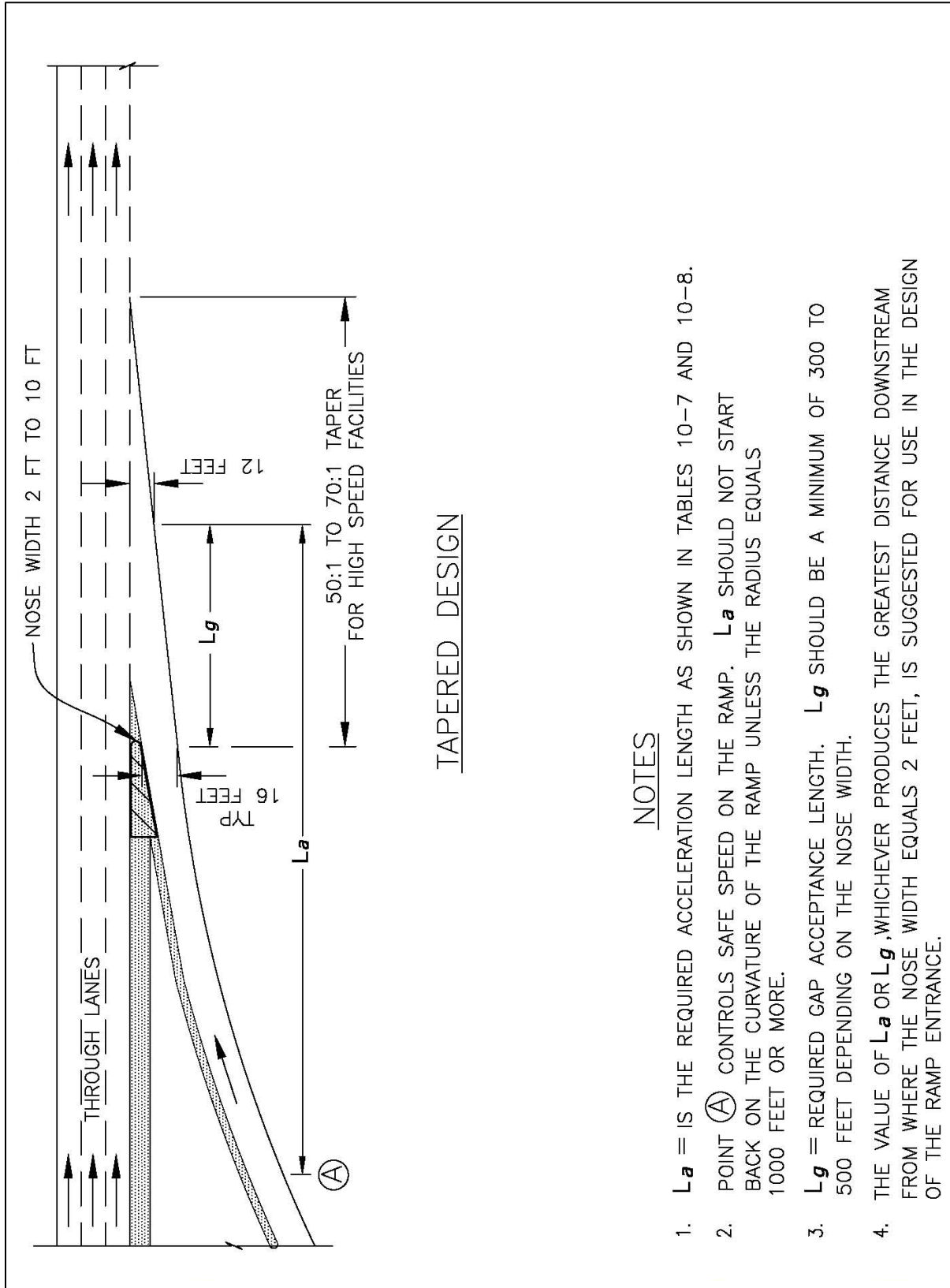

Table 10-4 [Table 10-3 of the PGDHS (1)] Minimum Acceleration Lengths for Entrance Terminals With Flat Grades of 2 Percent or Less

DESIGN SPEED OF HIGHWAY (mph)	DECELERATION LANES				
	Ratio of Length on Grade to Length on Level for Design Speed of Turning Curve (mph) ^a				
All speeds	3 to 4% UPGRADE 0.9			3 to 4% DOWNGRADE 1.2	
All speeds	5 to 6% UPGRADE 0.8			5 to 6% DOWNGRADE 1.35	
DESIGN SPEED OF HIGHWAY (mph)	ACCELERATION LANES				
	Ratio of Length on Grade to Length of Level for Design Speed of Turning Curve (mph) [*]				
	DESIGN SPEED OF TURNING ROADWAY CURVE, mph				
	20	30	40	50	All speeds
	3 to 4% UPGRADE			3 to 4% DOWNGRADE	
40	1.3	1.3	---	---	0.7
45	1.3	1.35	---	---	0.675
50	1.3	1.4	1.4	---	0.65
55	1.35	1.45	1.45	---	0.625
60	1.4	1.5	1.5	1.6	0.6
65	1.45	1.55	1.6	1.7	0.6
70	1.5	1.6	1.7	1.8	0.6
	5 to 6% UPGRADE			5 to 6% DOWNGRADE	
40	1.5	1.5	---	---	0.6
45	1.5	1.6	---	---	0.575
50	1.5	1.7	1.9	---	0.55
55	1.6	1.8	2.05	---	0.525
60	1.7	1.9	2.2	2.5	0.5
65	1.85	2.05	2.4	2.75	0.5
70	2.0	2.2	2.6	3.0	0.5

^{*} Ratio from this table multiplied by length in Table 10-3 or 10-4 gives length of speed-change lane on grade.

Table 10-5 [Table 10-4 of the PGDHS (1)] Speed-Change Lane Adjustment Factors as a Function of Grade



NOTES

1. L_a = IS THE REQUIRED ACCELERATION LENGTH AS SHOWN IN TABLES 10-7 AND 10-8.
2. POINT (A) CONTROLS SAFE SPEED ON THE RAMP. L_a SHOULD NOT START BACK ON THE CURVATURE OF THE RAMP UNLESS THE RADIUS EQUALS 1000 FEET OR MORE.
3. L_g = REQUIRED GAP ACCEPTANCE LENGTH. L_g SHOULD BE A MINIMUM OF 300 TO 500 FEET DEPENDING ON THE NOSE WIDTH.
4. THE VALUE OF L_a OR L_g ,WHICHEVER PRODUCES THE GREATEST DISTANCE DOWNSTREAM FROM WHERE THE NOSE WIDTH EQUALS 2 FEET, IS SUGGESTED FOR USE IN THE DESIGN OF THE RAMP ENTRANCE.

Figure 10-11A [Figure 10-69 of the PGDHS (1)] Typical Single-Lane Entrance Ramps (Tapered)

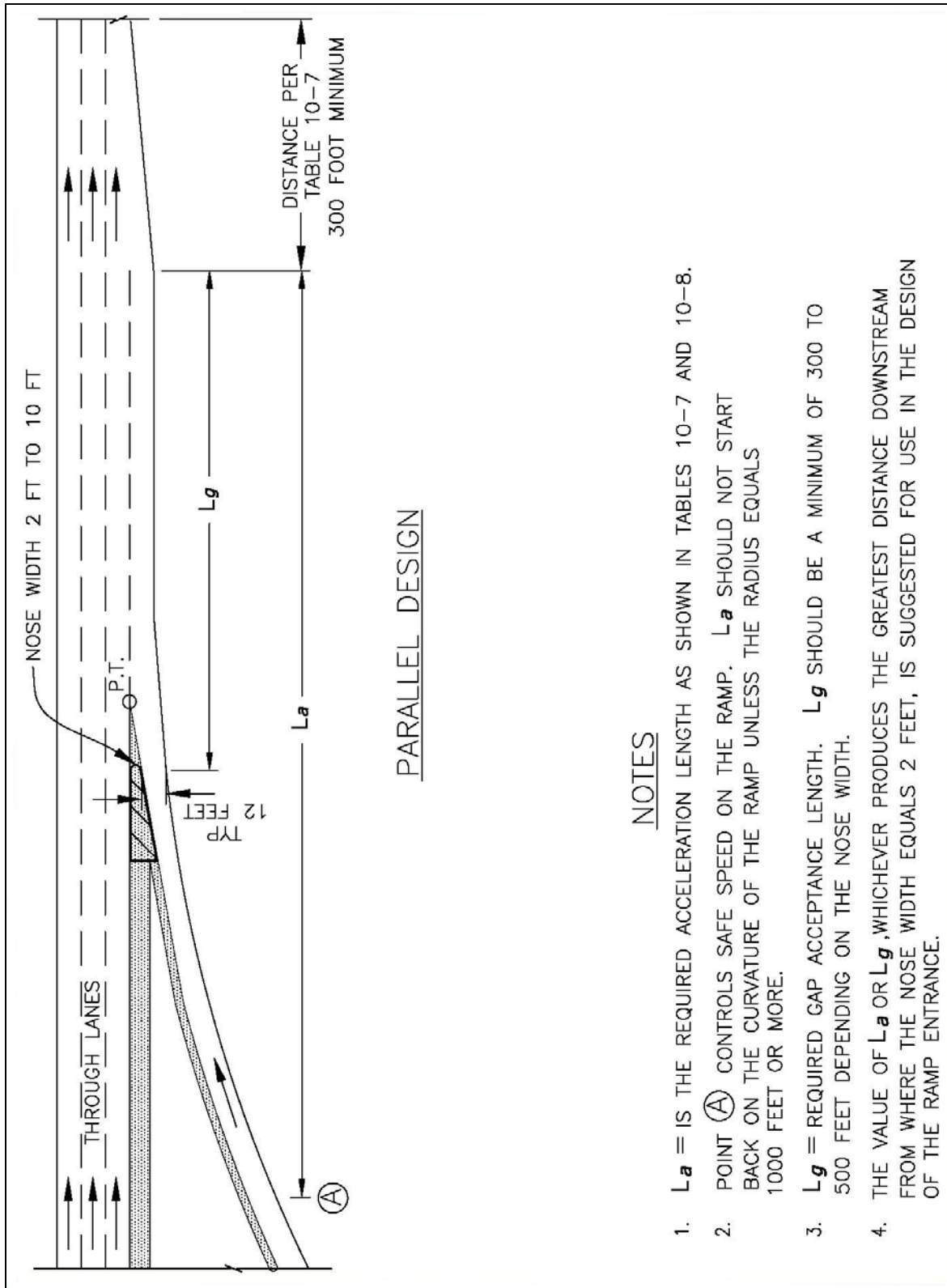

Figure 10-11B [Figure 10-69 of the PGDHS (1)] Typical Single-Lane Entrance Ramps (Parallel) (Preferred)

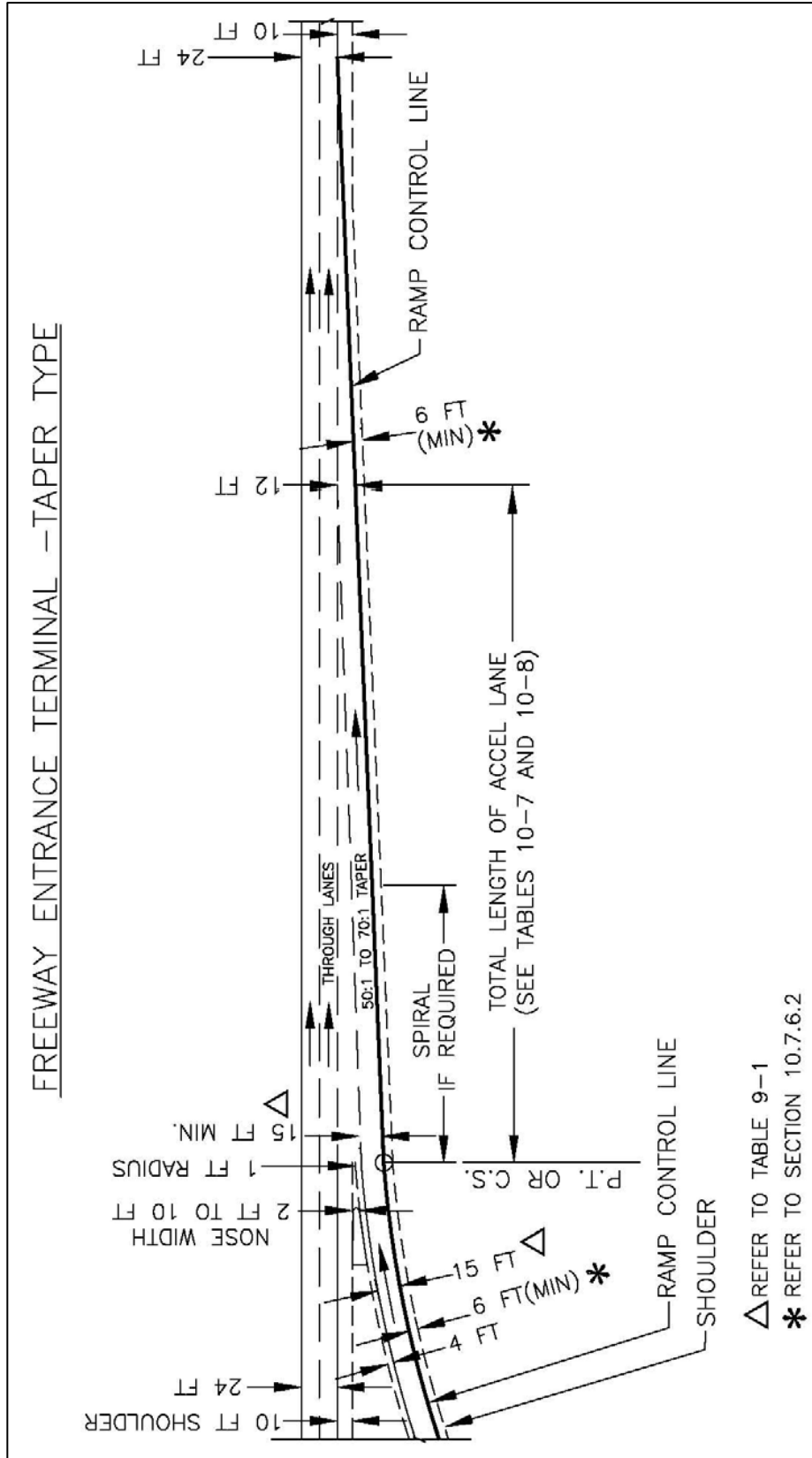

Figure 10-12 Freeway Entrance Terminal – Taper Type

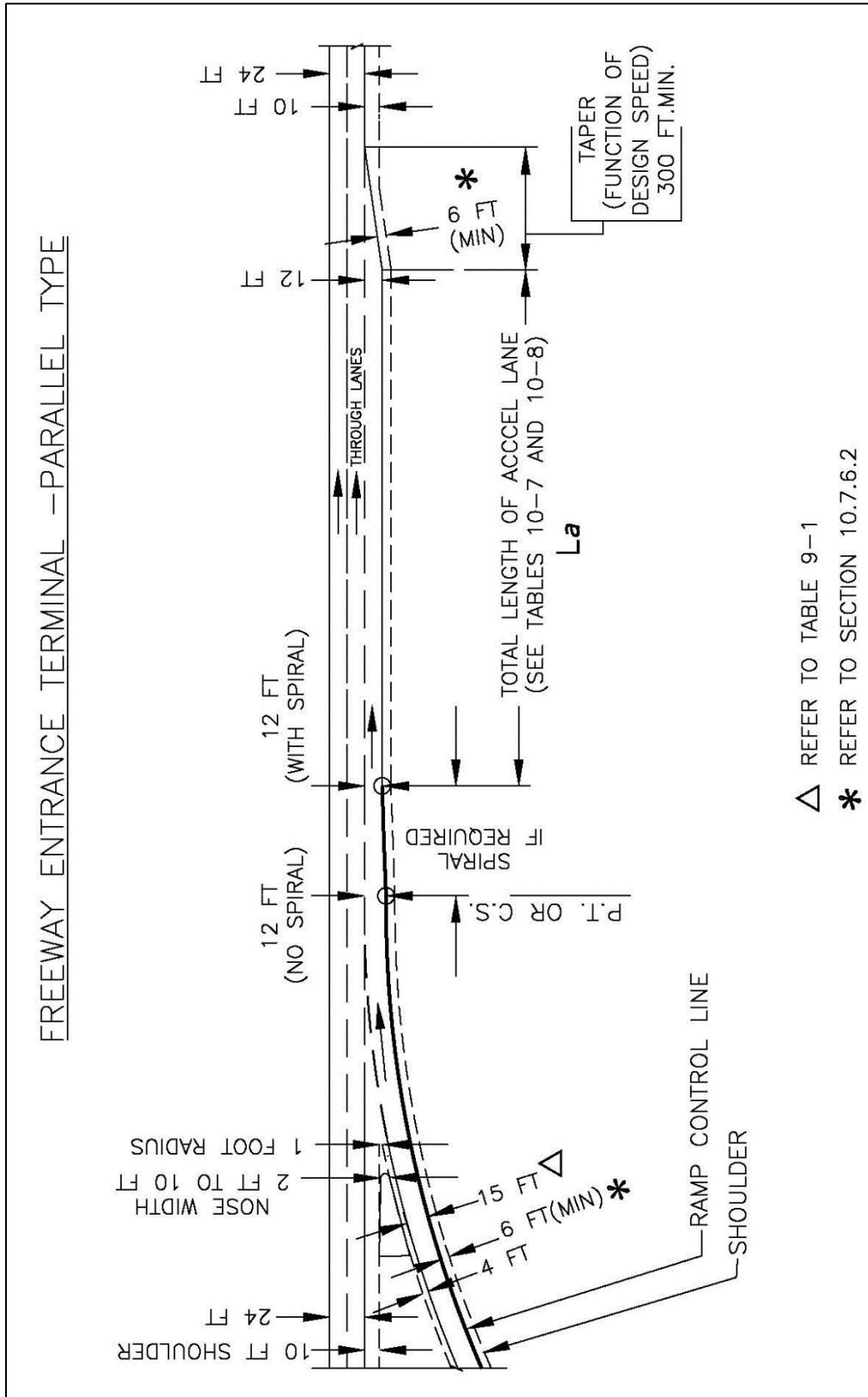

Figure 10-13 Freeway Entrance Terminal – Parallel Type (Preferred)

10.7.7 Single Lane Free-Flow Terminals, Entrances

Design of entrance ramp terminals should conform to the standard designs illustrated by Figures 10-11A, 10-11B, 10-12 and 10-13. Single lane ramps should be designed for one lane, passing permitted operation. It is up to the design engineer, with the approval of the project manager, to determine the type of ramp terminal, parallel type or taper type, at each location, although there should be an effort to obtain consistency in a corridor.

10.7.7.1 Taper Type Entrance

The taper type entrance of proper dimensions usually operates smoothly at all volumes up to and including the design capacity of merging areas. By relatively minor speed adjustment, the entering driver can see and use an available gap in the through-traffic lane. The taper type entrance allows for the ability to provide proper superelevation transitions from the curve to the tangent section in the long, triangular gore area.

10.7.7.2 Parallel Type Entrance

The parallel type provides an added lane of sufficient length to enable a vehicle to accelerate to near-freeway speed prior to merging. A taper is provided at the end of the added lane. A 300-foot taper is the normal length of taper for design speeds up to 70 mph. The parallel type entrance is preferred over the taper type entrance.

Desirably, a curve with a radius of 1000 feet or more and a length of at least 200 feet should be provided in advance of the added lane. If this curve has a short radius, motorists tend to drive directly onto the freeway without using the acceleration lane. This behavior results in undesirable merging operation. The length of the parallel lane is generally measured from the point where the left edge of the traveled way of the ramp joins the traveled way of the freeway to the beginning of the taper. If the curve approaching the acceleration lane has a long radius of 1,000 feet or more, and the motorist has an unobstructed view of traffic on the freeway to the left, a part of the ramp proper may be considered as part of the acceleration lane.

The operational and safety benefits of long acceleration lanes are well-recognized, particularly where both the freeway and ramp carry high-traffic volumes. A long acceleration lane provides more time for the merging vehicles to find an opening in the through-traffic stream. An acceleration length of at least 1,200 ft, plus the taper, is desirable whenever it is anticipated that the ramp and freeway will carry traffic volumes approximately equal to the design capacity of the merging area.

The disadvantage of the parallel type is the general inability to design and construct the entrance curve with the proper superelevation transitions. This is particularly evident when concrete pavement is used and the shoulder is paved concurrently with the mainline paving.

10.7.8 Single-Lane Free-Flow Terminals, Exits

Design of exit ramp terminals should conform to the standard designs illustrated by Figures 10-14 and 10-15. Single-lane ramps should be designed for one lane, passing permitted operation.

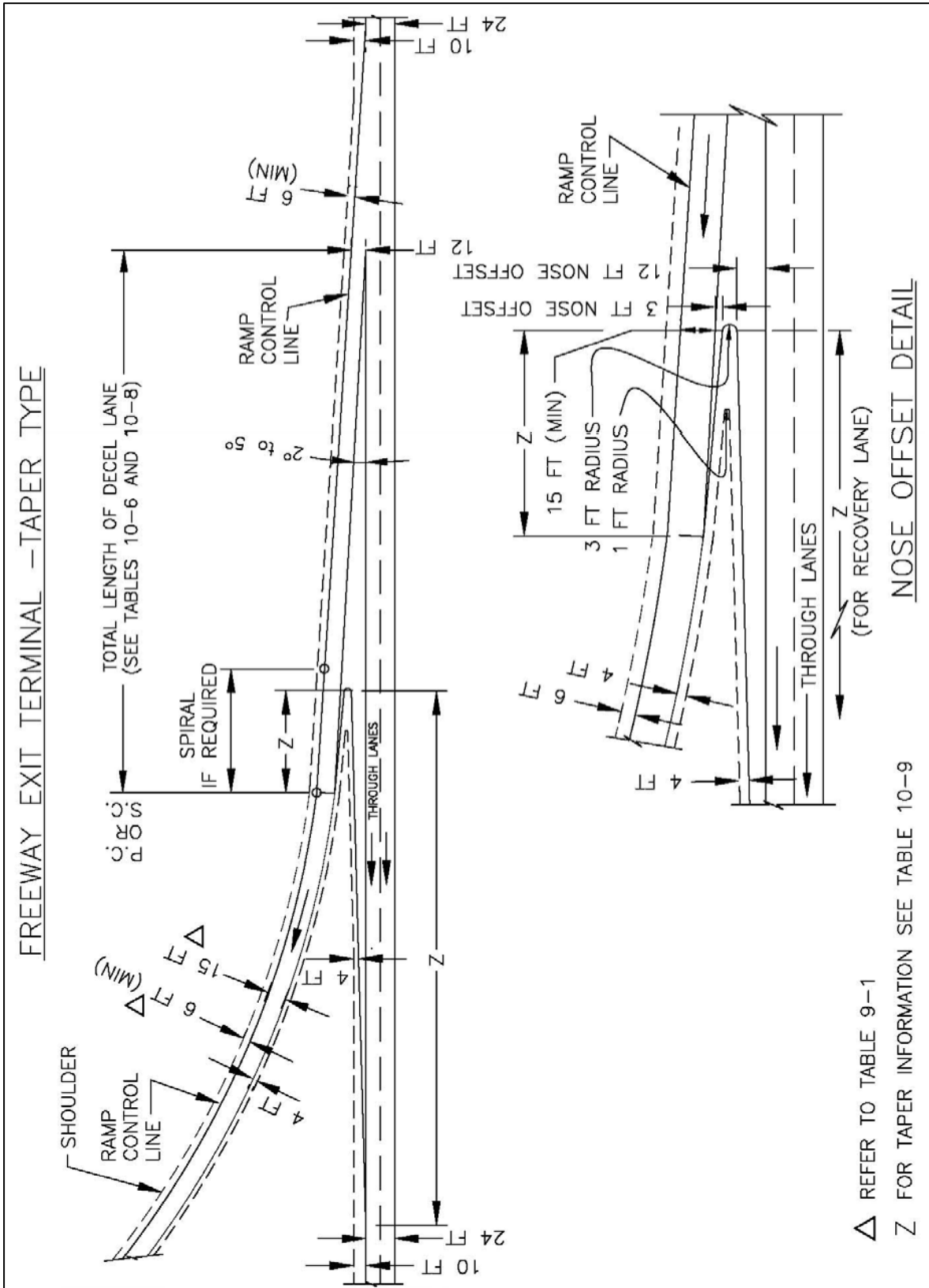

Figure 10-14 Freeway Exit Terminal – Taper Type

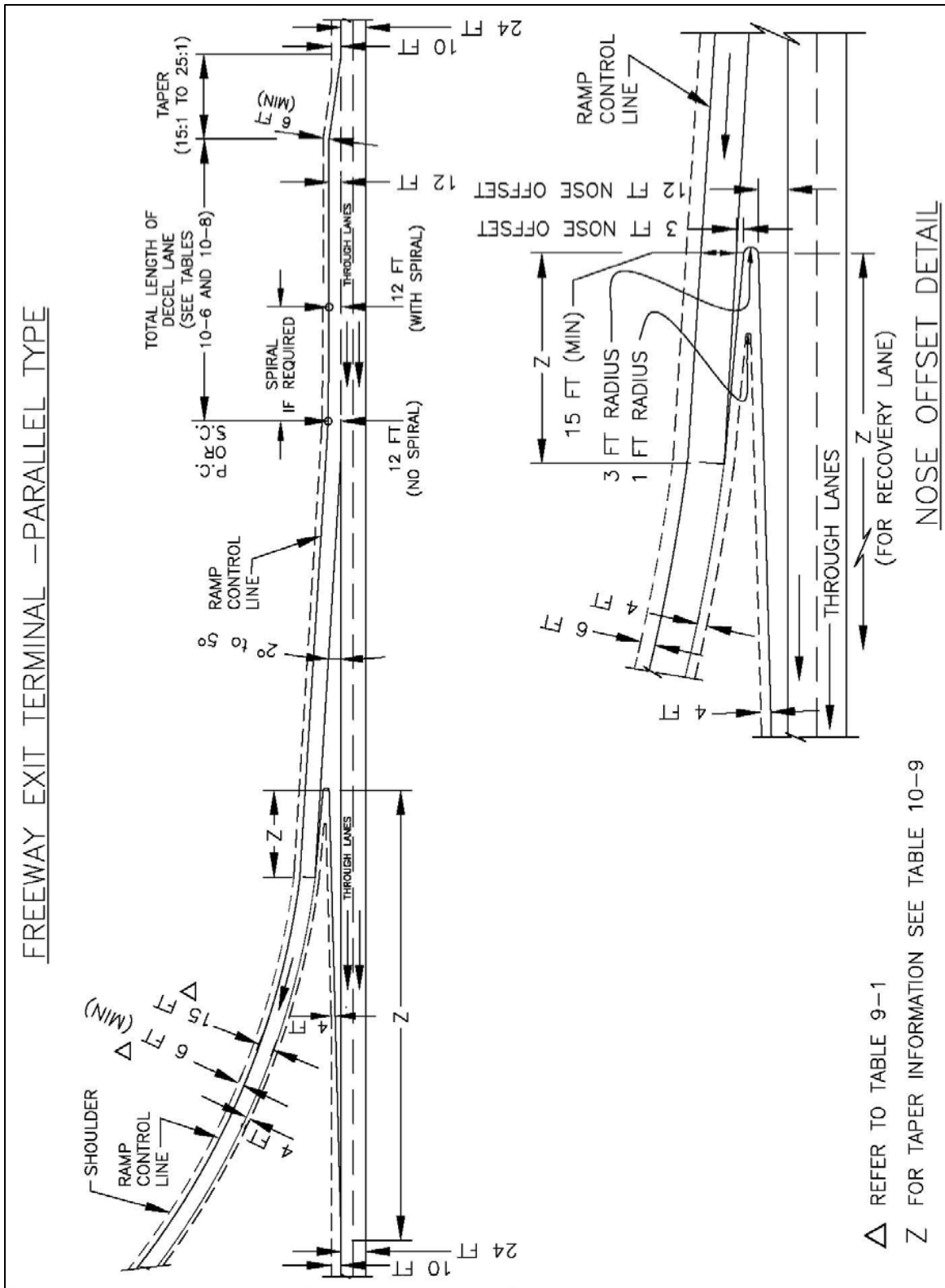

Figure 10-15 Freeway Exit Terminal – Parallel Type

Design Speed of Approach Highway	Length of Nose Taper (Z) Per Unit Width of Nose Offset
30	15.0
35	17.5
40	20.0
45	22.5
50	25.0
55	27.5
60	30.0
65	32.5
70	35.0
75	37.5

Table 10-6 [Table 10-2 of the PGDHS (1)] Minimum Length of Taper Beyond an Offset Nose

10.7.8.1 Taper Type Exits

The taper-type exit fits the direct path preferred by most drivers, permitting them to follow an easy path within the diverging area. Vehicles leave the through lane at a higher speed than on the parallel type thereby reducing the possibilities of rear-end collisions. Deceleration is accomplished on the taper, once the vehicle has left the through lanes. The length for deceleration begins at the point where the deceleration lane is 12 feet wide and extends to the point controlling the safe speed for the ramp, usually the PC of the exit curve. The divergence angle is usually between 2 and 5 degrees.

The taper-type exit terminal design can be used advantageously in developing the desired long, narrow, triangular emergency maneuver area just upstream from the exit nose. The taper configuration also works well in the length-width superelevation adjustments to effect a ramp cross slope different from that of the through lane.

10.7.8.2 Parallel Type Exits

A parallel-type exit terminal usually begins with a taper, followed by a derived length of added full lane that is parallel to the traveled way. This design assumes that driver will exit near the beginning of the added lane, and effect speed change thereafter. It requires a reverse-curve maneuver that is somewhat unnatural. Some drivers may choose to avoid the reverse-curve exit path and turn directly off the through lane in the vicinity of the exit nose. This may result in undesirable deceleration on the through lane, in undesirable conflict on the deceleration lane, or in excessive speed in the exit-nose area.

The length of a parallel-type deceleration lane is usually measured from the point where the added lane attains a 12-foot width to the point where the alignment of the ramp roadway departs from the alignment of the freeway. Longer parallel-type deceleration lanes are more likely to be used properly.

The taper portion of the exit should be 15:1 to 25:1.

10.7.8.3 Free-Flow Terminals on Curves

If an exit ramp is required at a sharp left-hand curve, the change in superelevation from the main line to the ramp can be troublesome. Sometimes this change in superelevation can be transitioned smoothly using a long taper-type design.

A parallel-type design in this situation usually results in adverse superelevation on the exit curve. This can result in operational problems at the exit, particularly when snow and ice are present.

If an exit ramp is required near the beginning of a curve on the mainline, a taper-type exit may cause traffic in the right-most lane to follow the ramp. In this case, a separate and parallel ramp upstream of the PC may be required. Another option would be to move the exit taper to a point in advance of the PC of the curve thus avoiding the tendency of traffic in the right-most lane to follow the ramp. See Figure 10-71 of the *PGDHS (1)* for layout.

10.7.8.4 At-Grade Terminals

Ramps in metropolitan areas may require additional lanes to provide storage space for vehicles waiting to cross or enter heavy city street traffic. See Figure 10-16A and 10-16B for examples of a single lane ramp exit transition to two lanes. Contact the Region Traffic Engineer for required storage lengths.

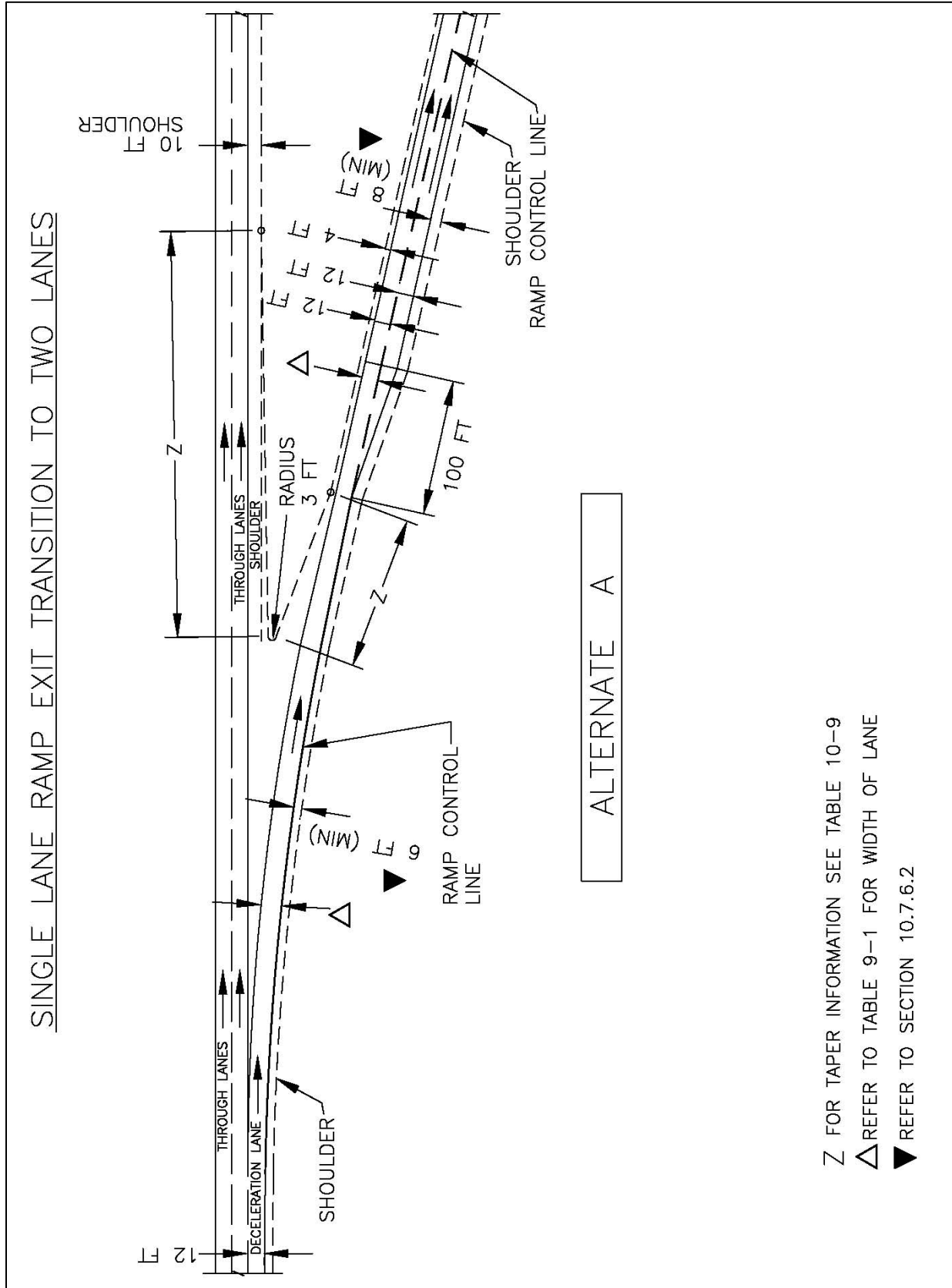

Figure 10-16A Single-Lane Ramp Exit Transition to Two Lanes (Alternate A)

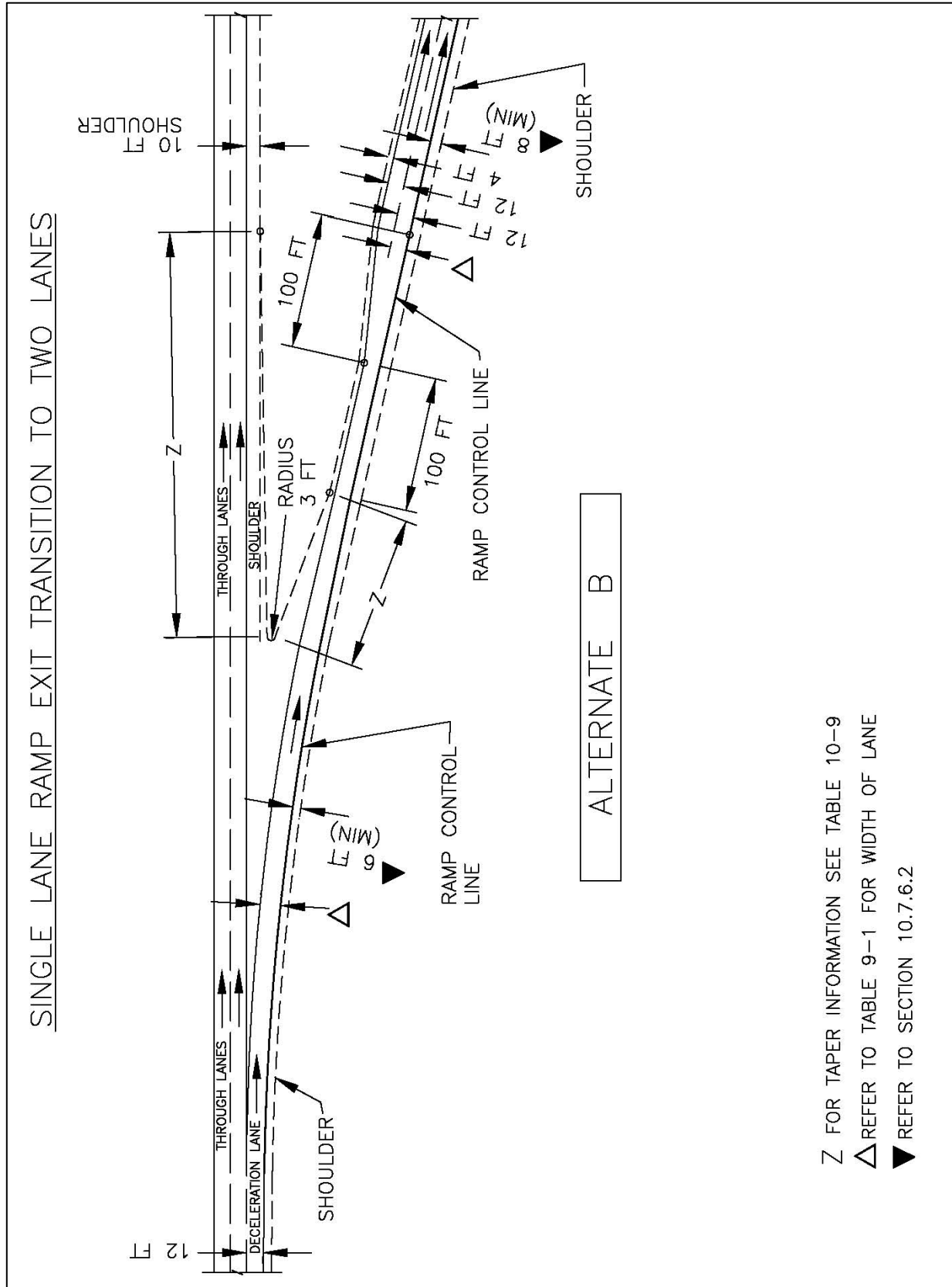

Figure 10-16B Single-Lane Ramp Exit Transition to Two Lanes (Alternate B)

10.7.9 Multilane Free-Flow Terminals

Multilane terminals are required where traffic is too great for single-lane operation. The most common multilane terminals consist of two-lane entrances and exits at freeways. Other multilane terminals are sometimes termed "major forks" and "branch connections." The latter term denotes a separation and joining of two major routes.

10.7.9.1 Two-Lane Entrances

Two-lane entrances are warranted for either a branch connection, ramp metering, or in situations created by capacity requirements on the on-ramp. To satisfy lane-balance requirements, at least one additional lane must be provided downstream. This additional lane may be a basic lane if also required for capacity, or an auxiliary lane that may be dropped 2,500 to 3,000 feet downstream or at the next interchange. In some cases, two additional lanes may be necessary because of capacity requirements. This will result in a right lane drop on the two-lane ramp, rather than a forced inside-lane merge on the classic taper-type two-lane entrance. In some cases, where volumes on the two-lane ramp are at the lower end, the outer edge of pavement may be continuously tapered, usually on a 50:1, with the striping showing a right-lane drop. In no case should a two-lane ramp be striped for an inside merge with the right lane being the continuous lane. In areas where interchanges are closely spaced, one lane may become a continuous auxiliary lane.

10.7.9.2 Two-Lane Exits

Where traffic leaving the freeway at an exit terminal exceeds the design capacity of a single lane, it is necessary to provide a two-lane exit terminal. To satisfy lane balance requirements and not reduce the basic number of through lanes, it is usually necessary to add an auxiliary lane upstream from the exit. See Figure 10-18.

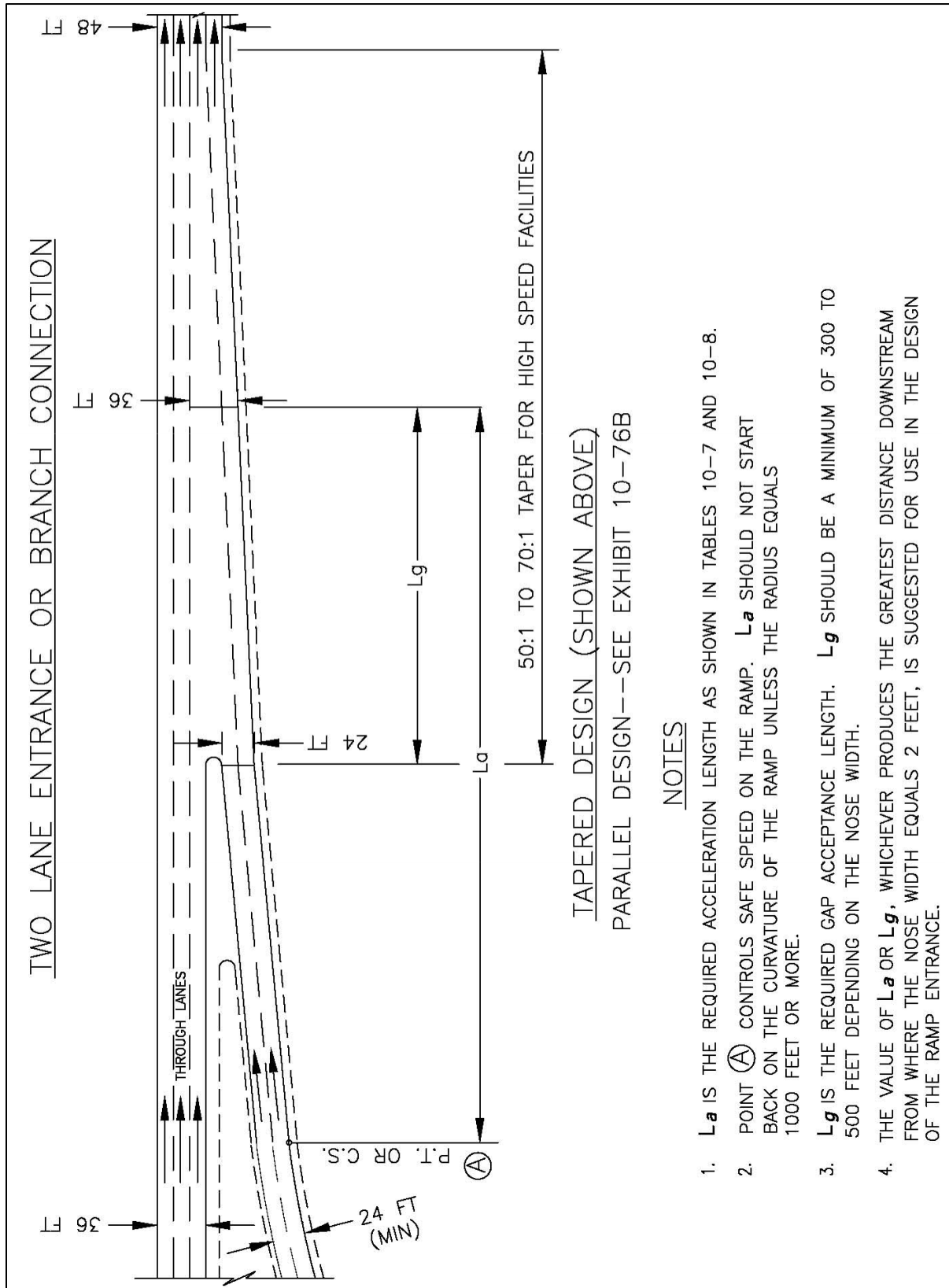

Figure 10-17 Two-Lane Entrance or Branch Connection

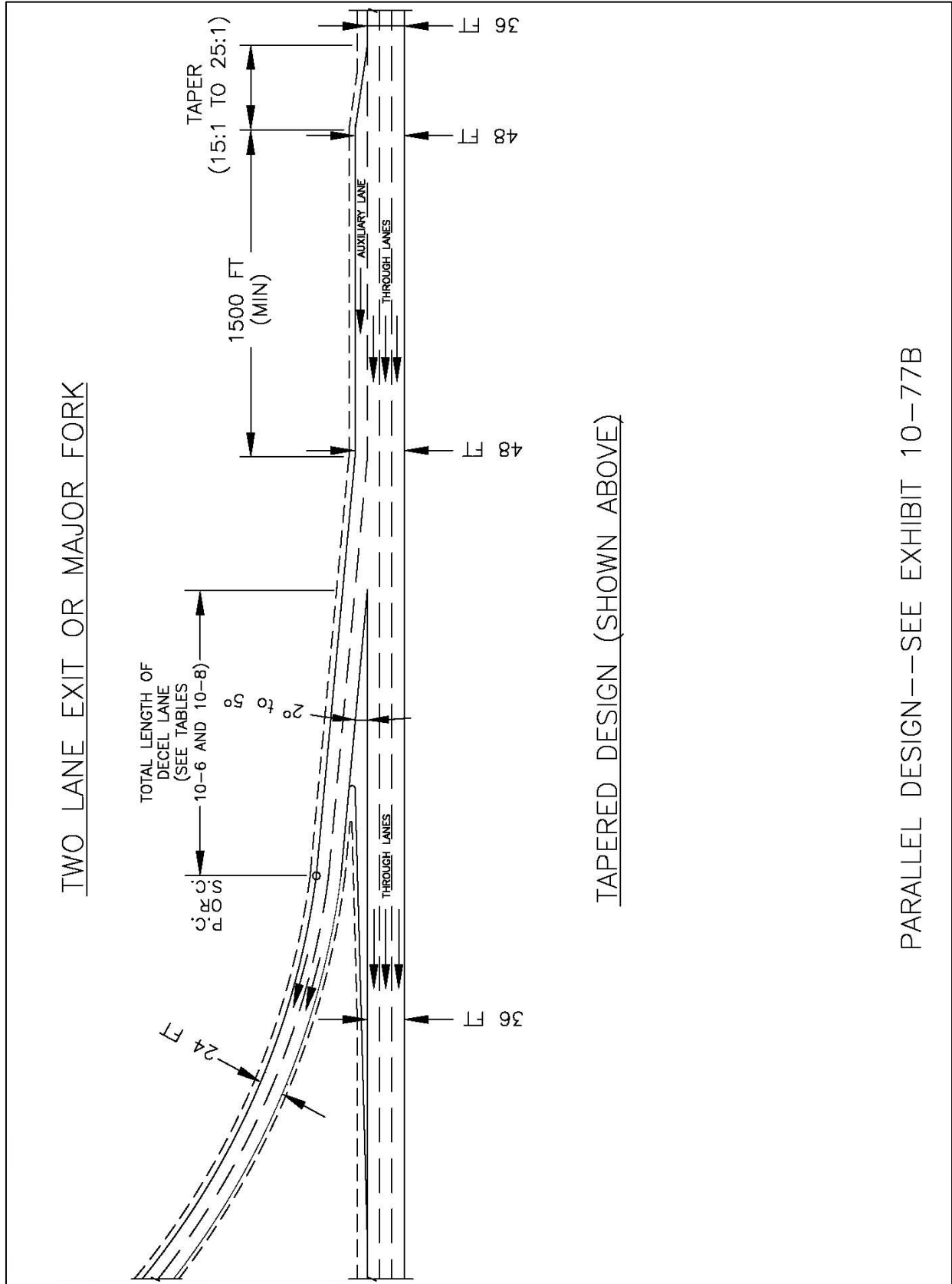

Figure 10-18 Two Lane Exit or Major Fork

On two-lane parallel type exits, the total length from the beginning of the first taper to the point where the ramp traveled-way departs from the right-hand through lane of the freeway should range from 2,500 feet for turning volumes of 1,500 VPH or less upward to 3,500 feet for turning volumes of 3,000 VPH.

If the design year estimated volumes exceed 1,500 equivalent passenger cars per hour (PCPH), a two-lane width of ramp should be provided initially. For volumes less than 1,500 but more than 900 PCPH, a one-lane width exit ramp should be provided with provision for adding an auxiliary lane and an additional lane on the ramp. Provisions may be made for widening to three or even four lanes at the crossroad intersection, depending on the capacity of the intersection. Design of ramp terminals for two-lane exits should conform to the standard designs illustrated by Figure 10-18.

For two-lane exits, the preferred type is the taper type for the same reasons identified previously on the single-lane exit. For the parallel type, traffic in the outer through lanes of the freeway must change lanes twice to exit on the right-hand lane of the exit ramp. This requires considerable lane changing to operate efficiently. Also, the parallel type requires a longer distance from beginning of the taper to the exit nose to develop the full capacity of the ramp.

10.7.9.3 Major Forks and Branch Connections and Freeway-to-Freeway Connections

A major fork is defined as:

- The bifurcation of a directional roadway of a terminating freeway route into two directional multilane ramps that connect to another freeway, or
- The separation of a freeway route into two separate freeway routes of equal importance.

The design of major forks is subject to the same principles of lane balance as any other diverging area. The total number of lanes in the two roadways beyond the divergence should exceed the number of lanes approaching the diverging area by at least one. See Chapter 10 of the PGDHS (1) for additional information.

A branch connection is defined as the beginning of a directional roadway of a freeway formed by the convergence of two directional multilane ramps from another freeway or by the convergence of two freeway routes to form a single freeway route. See Figure 10-76 in the *PGDHS (1)*.

10.8 PEDESTRIAN AND BICYCLE ACCOMMODATION

The accommodation of pedestrians and bicycles through urban interchanges should be considered early in the development of interchange configurations. High density land use near interchanges can generate heavy bike and pedestrian movements, resulting in conflicts between vehicles and bicycles or vehicles and pedestrians.

10.9 RAMP METERING

The purpose of ramp metering is to reduce congestion or improve operations on urban freeways. The metering may be limited to only one ramp or integrated into a series of entrance ramps.

Ramp metering consists of traffic signals installed on entrance ramps in advance of the entrance terminal to control the number of vehicles entering the freeway. The traffic signals may be pre-timed or traffic actuated to release the entering vehicles individually or in platoons.

Contact the Region Traffic Engineer for design considerations.

REFERENCES

1. AASHTO. *A Policy on Geometric Design of Highways and Streets*, American Association of State Highway and Transportation Officials, Washington, D.C.: 2011.
2. CDOT Policy Directive 1601.0, Interchange Approval Process January 2004.
3. TRB. *Highway Capacity Manual*, Transportation Research Board, National Research Council, Washington, D.C.: 2010.
4. Caltrans. *Caltrans Highway Design Manual, Sixth Edition*. California Department of Transportation, Sacramento, CA., 2017
5. CDOT. *Standard Plans - M & S Standards*, Colorado Department of Transportation, 2012.
6. AASHTO. *Roadside Design Guide* American Association of State Highway and Transportation Officials, Washington D.C.: 2011